

# Tarifa Calefacción

03.2026





FONTANERÍA | CALEFACCIÓN | CLIMATIZACIÓN  
GAS | VENTILACIÓN | BAÑO | PISCINA  
BOMBAS | DEPÓSITOS | RIEGO  
FIJACIÓN | HERRAMIENTAS

# Índice

<b>01</b>	<b>Calefacción</b>	01. CALDERAS GASÓLEO -----	08
		02. CALDERAS BIOMASA -----	12
		03. ESTUFAS -----	16
		04. INSERTABLES -----	19
		05. COCINAS DE LEÑA -----	22
		06. CALDERAS MURALES -----	23
<b>02</b>	<b>Emisores</b>	01. RADIADORES DE ALUMINIO -----	28
		02. PANELES DE ACERO -----	30
		03. TOALLEROS HIDRÁULICOS -----	34
		04. TOALLEROS ELÉCTRICOS -----	35
<b>03</b>	<b>ACS y Acumulación</b>	01. TERMOS ELÉCTRICOS -----	38
		02. DEPÓSITOS ACS VALINOX -----	42
		03. DEPÓSITOS ACS COBALLES -----	44
		04. DEPÓSITOS ACS INEROX -----	47
		05. DEPÓSITOS ACS DOMUSA -----	48
		06. DEPÓSITOS INERCIA -----	49
		07. CALENTADORES GAS -----	51
<b>04</b>	<b>Regulación y Control</b>	01. MANOMETRÍA E INSTRUMENTACIÓN -----	54
		02. VASOS DE EXPANSIÓN -----	83
<b>05</b>	<b>Bombas Circuladoras</b>	01. BOMBAS CALEFACCIÓN Y ACS DAB -----	88
		02. BOMBAS CALEFACCIÓN Y ACS GRUNDFOS -----	90

# 06 Conductos Chimeneas

01. DINAK DP	94
02. DW PELLETS	98
03. DINAK SW	99
04. DEKO LEÑA	103
05. DEKO PELLETS CLASSIC	105
06. DINAK PPH SW	107
07. DINAK PPH CONCENTRIC	109
08. DINAK ALU SW	110
09. DINAK ALU CONCENTRIC	112
10. CONDUCTORES FLEXIBLES	113

CONDICIONES DE VENTA	115
----------------------	-----



# Calefacción

01

## 01. Calderas Gasóleo

## Evolution EV HFM / EV HFC

Caldera de condensación estanca de hierro fundido.  
4 Potencias: de 20 a 40 kW.  
Producción de ACS instantánea o sólo calefacción.  
Producción de agua caliente sanitaria de forma modulante.  
Consumo Reducido.  
Bajo nivel sonoro.



MODELO	POTENCIA ÚTIL 50/30°C	POTENCIA ÚTIL 80/60°C	PROD. ACS ΔT30°C	PROD. ACS ΔT25°C	CLASE ENERGÉTICA	REFERENCIA	PRECIO
EVO. EV 30 HFM	30,2 kW	28,7 kW	13,7 L/min	16,4 L/min	A/A	TEVO000042	<b>3 562 €</b>
EVO. EV 40 HFM	40,5 kW	38,7 kW	18,4 L/min	22,1 L/min	A/A	TEVO000043	<b>3 686 €</b>
EVO. EV 20 HFC	20,3 kW	19,1 kW	-	-	A/A	TEVO000041	<b>3 112 €</b>
EVO. EV 30 HFC	30,2 kW	28,7 kW	-	-	A/A	TEVO000048	<b>3 225 €</b>
EVO. EV 40 HFC	40,5 kW	38,7 kW	-	-	A/A	TEVO000049	<b>3 325 €</b>

## OPCIONES

TASA DE RECICLAJE INCLUIDA

KIT PARA SUELO RADIANTE SRFC2 PARA EVOLUTION EV 30/40 HFC	TKITSRF016	<b>433 €</b>
KIT PARA SUELO RADIANTE SRFM2 PARA EVOLUTION EV 30 HFM	TKITSRF014	<b>433 €</b>
KIT PARA SUELO RADIANTE SRFM2 PARA EVOLUTION EV 40 HFM	TKITSRF015	<b>433 €</b>
SONDA PARA ACUMULADOR	CELC000211	<b>16 €</b>

## MCF HDX / HDXV / HDX / HDXV

Caldera de hierro fundido (con control electrónico).  
Grupo técnico con acumulador INOX.  
3 Potencias: en tiro natural de 29 a 52 kW.  
2 Potencias: con cámara estanca de 29 a 40 kW.  
Sistema hidráulico de doble bomba.  
Purgadores automáticos de doble seguridad.



MODELO	POTENCIA ÚTIL	SALIDA GASES	CLASE ENERGÉTICA	REFERENCIA ACUM. 100 L	PRECIO	REFERENCIA ACUM. 130 L	PRECIO
MCF 30 HDX	27,8 kW	Tiro natural	B/B	TMCX000103	<b>3 712 €</b>	TMCX000105	<b>3 920 €</b>
MCF 40 HDX	38,5 kW	Tiro natural	B/B	TMCX000104	<b>3 916 €</b>	TMCX000106	<b>4 106 €</b>
MCF 50 HDX	49,7 kW	Tiro natural	B/B	TMCX000107	<b>4 337 €</b>	TMCX000108	<b>4 543 €</b>
MCF 30 HDXV	27,8 kW	Estanca	B/B	TMCXV00024	<b>3 951 €</b>	TMCXV00026	<b>4 149 €</b>
MCF 40 HDXV	38,5 kW	Estanca	B/B	TMCXV00025	<b>4 144 €</b>	TMCXV00027	<b>4 334 €</b>

## OPCIONES

TASA DE RECICLAJE INCLUIDA

PROGRAMADOR DIARIO ANALÓGICO	TPRO000000	<b>74 €</b>
PROTECCIÓN CATÓDICA DX	TKITSAN000	<b>170 €</b>

## Clima Plus H / HFD

Clima Plus H: Caldera de Acero  
Clima Plus HFD: Caldera de Hierro Fundido  
1 Versión: Calefacción y ACS instantánea  
Clima Plus H: 2 Potencias 27 y 37 kW  
Clima Plus HFD: 1 Potencia 28 kW  
Temperatura de agua caliente sanitaria estable.



INCLUYE  
DESPLAZAMIENTO,  
MANO DE OBRA  
Y REPUESTOS

\*OPCIONAL  
TERMOSTATO CONECTABLE  
COMFORT WIFI



MODELO	POTENCIA ÚTIL	PROD. ACS ΔT30°C	CLASE ENERGÉTICA	REFERENCIA	PRECIO
CLIMA PLUS H 25	26,5 kW	12,6 L/min	B/B	TCLIM00017	<b>2 205 €</b>
CLIMA PLUS H 35	36,8 kW	17,5 L/min	B/B	TCLIM00019	<b>2 347 €</b>
CLIMA PLUS HFD 30	28,1 kW	13,4 L/min	B/B	TCLIM00016	<b>2 413 €</b>

**OPCIONES** TASA DE RECICLAJE INCLUIDA

PROGRAMADOR DIARIO ANALÓGICO	TPRO000000	<b>74 €</b>
------------------------------	------------	-------------

## Jaka HFD

Grupo térmico de fundición.  
4 Potencias: de 29 a 64 kW  
Con quemador.  
Evacuación de gases a tiro forzado.  
Opciones para instalaciones de suelo radiante.  
Cuerpo de combustión en hierro fundido.



INCLUYE  
DESPLAZAMIENTO,  
MANO DE OBRA  
Y REPUESTOS

\*OPCIONAL  
TERMOSTATO CONECTABLE  
COMFORT WIFI



MODELO	POTENCIA ÚTIL	CLASE ENERGÉTICA	REFERENCIA	PRECIO
JAKA HFD 30	28,1 kW	B	TJAK000065	<b>1 612 €</b>
JAKA HFD 40	39,4 kW	B	TJAK000066	<b>1 730 €</b>
JAKA HFD 50	50,8 kW	B	TJAK000067	<b>1 900 €</b>
JAKA HFD 60	60,7 kW	B	TJAK000068	<b>2 243 €</b>

TASA DE RECICLAJE INCLUIDA

## Jaka HFD Condens

Caldera descondensación de hierro fundido.  
Sólo calefacción.  
2 Potencias: 20 y 30 kW.  
Consumo reducido.



MODELO	PROD. ACS $\Delta T 30^{\circ}\text{C}$	PROD. ACS $\Delta T 30^{\circ}\text{C}$	CLASE ENERGÉTICA	REFERENCIA	PRECIO
JAKA HFD 20 CONDENS	20,3 kW	19,1 kW	A	TJAK000071	<b>2 735 €</b>
JAKA HFD 30 CONDENS	30,2 kW	28,7 kW	A	TJAK000072	<b>2 831 €</b>

### OPCIONES

TASA DE RECICLAJE INCLUIDA

KIT HIDRÁULICO PARA JAKA HFD CONDENS	TKITJAF004	<b>603 €</b>
--------------------------------------	------------	--------------

## Jaka HFC

Grupo térmico de fundición sin quemador.  
6 Potencias: de 29 a 88 kW  
La puesta en marcha está incluida,  
si el conjunto va equipado con un quemador domestic.



\*OPCIONAL  
TERMOSTATO CONECTABLE  
COMFORT WIFI



MODELO	POTENCIA ÚTIL	SALIDA GASES	REFERENCIA ACUM. 130 L	PRECIO
JAKA HFS 30	28,1 kW	DOMESTIC D3 LN	TJAK000059	<b>1 051 €</b>
JAKA HFS 40	39,4 kW	DOMESTIC D4 LN	TJAK000060	<b>1 166 €</b>
JAKA HFS 50	50,8 kW	DOMESTIC D4 LN G	TJAK000061	<b>1 336 €</b>
JAKA HFS 60	60,7 kW	DOMESTIC D6 LN	TJAK000062	<b>1 506 €</b>
JAKA HFS 70	71,4 kW	-	TJAK000063	<b>1 694 €</b>
JAKA HFS 80	83,3 kW	-	TJAK000064	<b>1 899 €</b>

### OPCIONES

TASA DE RECICLAJE INCLUIDA

PROGRAMADOR DIARIO ANALÓGICO	TPRO000000	<b>74 €</b>
KIT HIDRÁULICO SRJ1 (HFS 30 / HFS 40 / HFS 50)	TKITSRJ003	<b>576 €</b>
CAPOT CUBRE QUEMADOR (JAKA HFS 30 / HFS 40 / HFS 50)	TCAP000006	<b>193 €</b>
CAPOT CUBRE QUEMADOR (JAKA HFS 60 / HFS 70 / HFS 80)	TCAP000007	<b>193 €</b>

## Domestic

Quemador de gasóleo.  
Potencias de 17 a 116 kW.



MODELO	POTENCIA MIN	POTENCIA MÁX	TIPO	PRECALENTADOR	POTENCIA MOTOR	REFERENCIA	PRECIO
DOMESTIC D3 LN	20,7 kW	33,2 kW	BAJO NOx	NO	110 W	TQDMVOC005	<b>598 €</b>
DOMESTIC D3 P LN	20,7 kW	33,2 kW	BAJO NOx	SI	110 W	TQDMVPC005	<b>678 €</b>
DOMESTIC D4 LN	28,4 kW	47,5 kW	BAJO NOx	NO	110 W	TQDMV0L005	<b>598 €</b>
DOMESTIC D4 P LN	28,4 kW	47,5 kW	BAJO NOx	SI	110 W	TQDMVPL005	<b>678 €</b>

## Sirena HFD

Caldera del hierro fundido (con control electrónico)  
2 Versiones: Calefacción / Calefacción + ACS instantánea  
3 Potencias: de 28 a 51 kW  
Sistema de doble bomba.  
Evacuación de gases a tipo forzado.  
Bajo nivel sonoro.



INCLUYE  
DESPLAZAMIENTO,  
MANO DE OBRA  
Y REPIESTOS.  
\*OPCIONAL  
TERMOSTATO CONECTABLE  
COMFORT WIFI



MODELO	POTENCIA ÚTIL	PROD. ACS ΔT30°C	CLASE ENERGÉTICA	REFERENCIA	PRECIO
MIX DUO HFD 30 E	28,1 kW	13,4 L/h	B/B	TSIRME00F2	<b>2 684 €</b>
MIX DUO HFD 40 E	39,4 kW	18,8 L/min	B/B	TSIRME00F3	<b>2 793 €</b>
CAL HFD 30 E	28,1 kW	-	B	TSIRCE00F3	<b>2 200 €</b>
CAL HFD 40 E	39,4 kW	-	B	TSIRCE00F4	<b>2 384 €</b>
CAL HFD 50 E	50,8 kW	-	B	TSIRCE00F5	<b>2 705 €</b>
MIX DUO HFD 30	28,1 kW	13,4 L/h	B/B	TSIRM00F12	<b>2 617 €</b>
MIX DUO HFD 40	39,4 kW	18,8 L/min	B/B	TSIRM00F13	<b>2 725 €</b>
CAL HFD 30	28,1 kW	-	B	TSIRC00F15	<b>2 130 €</b>
CAL HFD 40	39,4 kW	-	B	TSIRC00F16	<b>2 320 €</b>
CAL HFD 50	50,8 kW	-	B	TSIRC00F17	<b>2 633 €</b>

### OPCIONES SIRENA HFD E

TASA DE RECICLAJE INCLUIDA

PROGRAMADOR DIARIO ANALÓGICO	TPRO000000	<b>74 €</b>
KIT DE SUELO RADIANTE SRF2-30 (PARA HFD-30)	TKITSRF012	<b>437 €</b>
KIT DE SUELO RADIANTE SRF2-40 (PARA HFD-40 / HFD-50)	TKITSRF013	<b>437 €</b>

### OPCIONES SIRENA HFD

PROGRAMADOR DIARIO ANALÓGICO	TPRO000000	<b>74 €</b>
------------------------------	------------	-------------

## 02. Calderas Biomasa

### PELLETS

**DOMUSA**  
T E K N I K

#### Bioclass IC DX

Calefacción y ACS.  
Conectividad a través de la App "iConnect".  
Equipamiento completo.  
Limpieza automática.  
Control de combustión "Flame Logic"  
Acumulador inoxidable integrado.



iConnect **FLAME LOGIC**



MODELO	POTENCIA NOMINAL	POTENCIA CARGA PARCIAL	VOLUMEN AGUA CALDERA	VOLUMEN ACUMULADOR	CLASE ENERGÉTICA	REFERENCIA	PRECIO
BIOCLASS IC 18 DX	18 kW	5,2 kW	88 L	90 L	A++	TBIO000163	<b>4 682 €</b>
BIOCLASS IC 25 DX	25 kW	6,9 kW	104 L	120 L	A+	TBIO000164	<b>5 029 €</b>
*BIOCLASS IC 35 DX	34 kW	6,9 kW	109 L	120 L	A+	TBIO000182	<b>5 368 €</b>

TASA DE RECICLAJE INCLUIDA \*CONSULTAR STOCK

#### Bioclass IC

Calefacción.  
Conectividad a través de la App "iConnect".  
Limpieza automática.  
Control de combustión "Flame Logic"



iConnect **FLAME LOGIC**



MODELO	POTENCIA NOMINAL	POTENCIA CARGA PARCIAL	VOLUMEN AGUA CALDERA	VOLUMEN ACUMULADOR	CLASE ENERGÉTICA	REFERENCIA	PRECIO
BIOCLASS IC 18 DX	18 kW	5,2 kW	88 L	90 L	A++	TBIO000163	<b>4 682 €</b>
BIOCLASS IC 25 DX	25 kW	6,9 kW	104 L	120 L	A+	TBIO000164	<b>5 029 €</b>
*BIOCLASS IC 35 DX	34 kW	6,9 kW	109 L	120 L	A+	TBIO000182	<b>5 368 €</b>

#### DEPÓSITOS DE RESERVA - PARA BIOCLASS IC E IC DX

TASA DE RECICLAJE INCLUIDA \*CONSULTAR STOCK

DEPÓSITO DE RESERVA DX S	240 kg	TBIO000160	<b>524 €</b>
DEPÓSITO DE RESERVA DX L	365 kg	TBIO000161	<b>563 €</b>

#### Bioclass IC + DR



MODELO	CAPACIDAD DE PELLETS	REFERENCIA	PRECIO
*BIOCLASS IC 12 + DR	142 kg	TBIO000136	<b>4 430 €</b>
BIOCLASS IC 18 + DR	142 kg	TBIO000137	<b>4 606 €</b>
BIOCLASS IC 25 + DR	142 kg	TBIO000138	<b>4 877 €</b>
*BIOCLASS IC 35 + DR	142 kg	TBIO000155	<b>5 262 €</b>
*BIOCLASS IC 45 + DR	142 kg	TBIO000139	<b>5 635 €</b>

#### OPCIONES

TASA DE RECICLAJE INCLUIDA

SONDA DEL ACUMULADOR ACS / SONDA DEL TANQUE DE INERCIA	CELCO000300	<b>20 €</b>
--	-------------	-------------

## Easypell

Calefacción.  
Tolva almacenamiento incluida.  
Sensor de ACS  
Plato combustión con autolimpieza.  
Sensor de llama y presión.  
Regulador electrónico.



REFERENCIA	RANGO DE POTENCIA	VOLUMEN AGUA CALDERA	CAPACIDAD TOLVA	CLASE ENERGÉTICA	PRECIO
V16E	5 - 16 kW	70 L	165 kg	A+	<b>6 635 €</b>
V20E	6 - 20 kW	70 L	165 kg	A+	<b>6 820 €</b>
*V25E	8 - 25 kW	108 L	190 kg	A+	<b>7 918 €</b>
*V32E	10 - 32 kW	108 L	190 kg	A+	<b>8 130 €</b>

### CONDICIONES

\*CONSULTAR STOCK

SERVICIO DE PUESTA EN MARCHA

**100 €**

## Kit caldera de pellets + depósito combi con ACS instantanea

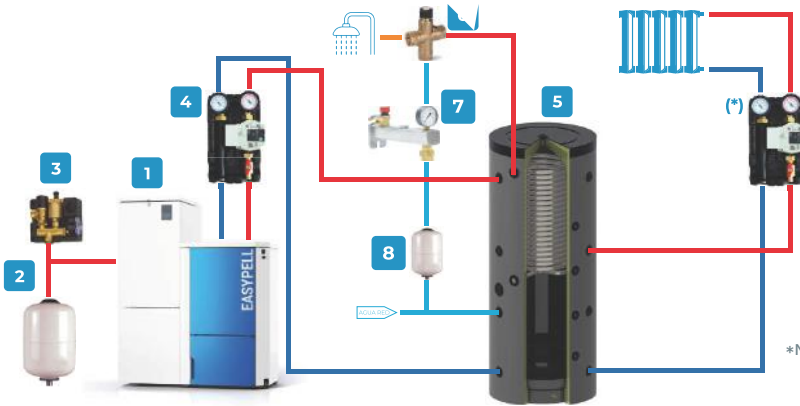

1. Caldera de pellets Easypell 16/20/25/32 kW.
2. Vaso de expansión 50 L y válvula.
3. Grupo de seguridad, purga y manómetro.
4. Grupo hidráulico directo DN20.

5. Depósito combi de inercia con producción de ACS 500 L.
6. Válvula mezcladora de ACS.
7. Grupo seguridad ACS.
8. Vaso de expansión ACS.

MODELO	POTENCIA NOMINAL	DESCRIPCIÓN	PRECIO
*KIT5E	16 kW	Caldera de pellets Easypell V16E	<b>8 735 €</b>
*KIT6E	20 kW	Caldera de pellets Easypell V20E	<b>8 840 €</b>
*KIT7E	25 kW	Caldera de pellets Easypell V25E	<b>9 978 €</b>
*KIT8E	32 kW	Caldera de pellets Easypell V32E	<b>10 068 €</b>

\*CONSULTAR STOCK

## DE LEÑA

## Solimax

Caldera de hierro fundido para leña y carbón.  
Control regulador de tiro termostático.  
Doble puerta frontal de carga y limpieza.  
Admite trozos de madera de grandes dimensiones: 320 x 315 mm.  
Presión máxima de trabajo: 4 bar.

LASIAN



MODELO	POTENCIA MADERA	POTENCIA CARBÓN	PROFUNDIDAD CÁMARA	VOLUMEN AGUA CALDERA	CLASE ENERGÉTICA	REFERENCIA	PRECIO
*SOLIMAX 20	23 kW	27 kW	300 mm	29 L	A+	1833	<b>1 858 €</b>
*SOLIMAX 30	30 kW	34 kW	405 mm	35,5 L	A+	1834	<b>2 121 €</b>
SOLIMAX 40	43 kW	48 kW	615 mm	48,5 L	A+	1835	<b>2 548 €</b>
*SOLIMAX 50	51 kW	56 kW	720 mm	55 L	A+	1836	<b>2 834 €</b>

\*CONSULTAR STOCK

## Vigas Clasic

Útiles de limpieza y cenicero incluidos.  
Combustión mediante aire primario y secundario.  
Termostato integrado y regulable.  
Pantalla indicadora de temperatura en la caldera.  
Serpentín antiembalamiento para evitar sobretemperaturas.  
Longitud máxima de leña 560 mm.

VIGAS



MODELO	POTENCIA NOMINAL	POTENCIA CARGA PARCIAL	VOLUMEN CÁMARA	VOLUMEN AGUA CALDERA	CLASE ENERGÉTICA	REFERENCIA	PRECIO
V25C	25 kW	10 kW	76 L	100 L	B	V25C	<b>2 250 €</b>
*V35C	35 kW	14 kW	101 L	115 L	B	V35C	<b>2 425 €</b>

\*CONSULTAR STOCK

## Vigas Gasificación

Display gráfico de fácil manejo.  
Control de termostato de vivienda, ACS o inercia.  
Serpentín antiembalamiento para evitar sobretemperaturas.  
Turbuladores y útiles de limpieza.  
Control de la combustión.  
Fabricada en chapa de acero de 6 mm.

VIGAS



MODELO	POTENCIA NOMINAL	POTENCIA CARGA PARCIAL	VOLUMEN CÁMARA	VOLUMEN AGUA CALDERA	CLASE ENERGÉTICA	REFERENCIA	PRECIO
V25S	25 kW	5 kW	120 L	115 L	A+	V25S	<b>4 442 €</b>
*V40S	40 kW	8 kW	185 L	115 L	A+	V40S	<b>5 690 €</b>

## ACCESORIOS

\*CONSULTAR STOCK

Cenicero metálico para la recogida de cenizas	VCEN	<b>67 €</b>	Válvula de descarga térmica	VDES	<b>101 €</b>
Pies metálicos para el soporte de la caldera	VP	<b>67 €</b>	Grupo elevación de la temperatura del retorno	VETR	<b>593 €</b>

## Kits Gasificación con Inercia

1. Caldera de gasificación 25/40 kW (estándar).
2. Pies de soporte, cenicero, útiles de limpieza y turbuladores.
3. Vaso de expansión y válvula (100/150 L).
4. Válvula de descarga térmica.
5. Grupo seguridad, purga y manómetro.
6. Grupo de elevación de la Tª de retorno con bomba electrónica.
7. Depósito de inercia (800/1000/1500 L).
8. Grupo hidráulico directo (no incluido en el kit)\*

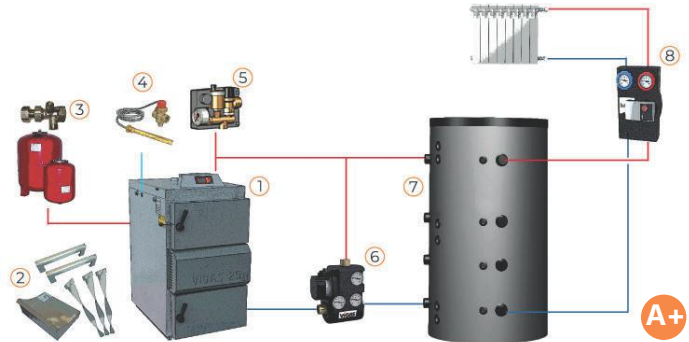

MODELO	POTENCIA NOMINAL	DESCRIPCIÓN	PRECIO
*KIT3G	25 kW	Caldera de gasificación de 25 kW / Depósito inercia 1 000 L / Vaso de expansión 100 L	6 552 €
*KIT5G	40 kW	Caldera de gasificación de 40 kW / Depósito inercia 1 000 L / Vaso de expansión 100 L	7 773 €

\*CONSULTAR STOCK

## Kits Gasificación con Producción Instantánea de ACS y Serpentin Solar

1. Caldera de gasificación 25/40 kW (estándar).
2. Pies de soporte, cenicero, útiles de limpieza y turbuladores.
3. Vaso de expansión y válvula (100/150 L).
4. Válvula de descarga térmica.
5. Grupo seguridad, purga y manómetro.
6. Grupo de elevación de la Tª de retorno con bomba electrónica.
7. Depósito de inercia, producción instantánea de ACS y serpentín solar (800/1000 L).
8. Válvula mezcladora para la producción de ACS.
9. Grupo hidráulico directo (no incluido en el kit)\*



MODELO	POTENCIA NOMINAL	DESCRIPCIÓN	PRECIO
*KIT7G	25 kW	Caldera de gasificación de 25 kW estándar / Serpentin solar 800 L / Vaso de expansión 100 L	7 518 €
*KIT9G	25 kW	Caldera de gasificación de 25 kW / Serpentin solar 1 000 L / Vaso de expansión 100 L	7 751 €
*KI11G	40 kW	Caldera de gasificación de 40 kW / Serpentin solar 1 000 L / Vaso de expansión 100 L	8 973 €

\*CONSULTAR STOCK

## POLICOMBUSTIBLES

## Dual Therm

Posibilidad de uso combinado con leña.  
Modulación electrónica.  
Cambio automático de combustible.  
Depósito de reserva de pellet integrado.  
Limpieza automática sistema anticondensados incluido.  
Encendido automático leña.

DOMUSA  
TEKNIK

INCLUYE  
DESPLAZAMIENTO,  
MANO DE OBRA  
Y REPUESTOS

\*OPCIONAL  
TERMOSTATO CONECTABLE  
COMFORT WIFI



MODELO	POTENCIA NOMINAL	VOLUMEN HOGAR	VOLUMEN AGUA CALDERA	CAPACIDAD PELLETS	LONGITUD MAX. LEÑA	REFERENCIA	PRECIO
DUAL THERM 25	25 kW	50 dm <sup>3</sup>	83 L	110 kg	50 cm	TDUA000000	<b>5 414 €</b>
*DUAL THERM 35	33 kW	70 dm <sup>3</sup>	97 L	97 kg	50 cm	TDUA000001	<b>5 873 €</b>

## OPCIONES

TASA DE RECICLAJE INCLUIDA \*CONSULTAR STOCK

SONDA DEL ACUMULADOR ACS / SONDA DEL TANQUE DE INERCIA	CELC000300	<b>20 €</b>
--	------------	-------------

## 03. Estufas

## TERMOESTUFAS DE PELLETS

## Termo Novara N

Bomba de alta eficiencia y vaso de expansión.  
Potencia térmica hasta 18,5 kW.  
Permite calefactar estancias de hasta 140 m<sup>2</sup>.  
Panel de control digital incluido.  
Termostato y seguridad contra el retorno de la llama.  
Válvula antideflagración y presostato.  
Gran capacidad del contenedor de pellets: 20 kg.

ferrolli

ecoDESIGN

WIFI READY  
MEDIANTE ACCESORIOMANDO  
A DISTANCIA

MODELO	POTENCIA NOMINAL	DIMENSIONES	RENDIMIENTO POTENCIA	CAPACIDAD PELLETS	CLASE ENERGÉTICA	REFERENCIA	PRECIO
TERMO NOVARA N	18,5 kW	1 016 x 600 x 590	92,8 %	20 kg	A+	OSS103XA	<b>4 960 €</b>

VERIFICACIÓN DE FUNCIONAMIENTO INCLUIDA. COSTE DE RECICLAJE 9 €

## Termo Modena

Bomba de alta eficiencia y vaso de expansión.  
Potencia térmica hasta 12,7 kW.  
Permite calefactar estancias de hasta 98 m<sup>2</sup>.  
Panel de control digital incluido.  
Termostato y seguridad contra el retorno de la llama.  
Válvula antideflagración y presostato.  
Gran capacidad del contenedor de pellets: 21,5 kg.

ferrolli

ecoDESIGN

WIFI READY  
MEDIANTE ACCESORIOMANDO  
A DISTANCIA

MODELO	POTENCIA NOMINAL	DIMENSIONES	RENDIMIENTO POTENCIA	CAPACIDAD PELLETS	CLASE ENERGÉTICA	REFERENCIA	PRECIO
TERMO MODENA	12,7 kW	1 100 x 549 x 649	91,69 %	21,5 kg	A+	1B3620117	<b>4 814 €</b>

VERIFICACIÓN DE FUNCIONAMIENTO INCLUIDA. COSTE DE RECICLAJE 9 €

**Elda**

Estufa de pellet homologada como ESTANCA, SEGURIDAD TOTAL para instalación incluso en dormitorios. Estos modelos están perfectamente sellados y aislados del ambiente: no consumen oxígeno de la habitación. Para la combustión cogen el aire del exterior (a través de tubo aspiración).

Ferrolí  
ecoDESIGN



MODELO	POTENCIA NOMINAL	DIMENSIONES	RENDIMIENTO POTENCIA	CAPACIDAD PELLETS	CLASE ENERGÉTICA	REFERENCIA	PRECIO
ELDA 7	6,9 kW	890 x 430 x 503	91,30 %	15 kg	A+	OSS033XA	<b>1 957 €</b>
ELDA 9	8,7 kW	975 x 460 x 538	95 %	22 kg	A+	OSS053XA	<b>2 240 €</b>
ELDA 11	10,7 kW	975 x 460 x 538	95 %	22 kg	A+	OSS073XA	<b>2 369 €</b>

VERIFICACIÓN DE FUNCIONAMIENTO INCLUIDA. COSTE DE RECICLAJE 5 €

**Corona**

Con estética cuidada y elegante de alta eficiencia energética con rendimiento de hasta el 94,3%. Gran autonomía gracias a su contenedor de 15/22 kg, según modelo. Apta para calefactar estancias de hasta 82 m<sup>2</sup>.

Ferrolí  
ecoDESIGN



MODELO	POTENCIA NOMINAL	DIMENSIONES	RENDIMIENTO POTENCIA	CAPACIDAD PELLETS	CLASE ENERGÉTICA	REFERENCIA	PRECIO
CORONA 7	6,8 kW	890 x 430 x 503	90,40 %	15 kg	A+	OSS023XA	<b>1 751 €</b>
CORONA 9	8,7 kW	975 x 460 x 538	94,30 %	22 kg	A+	OSS043XA	<b>1 957 €</b>
CORONA 11	10,6 kW	975 x 460 x 538	94,30 %	22 kg	A+	OSS063XA	<b>2 163 €</b>

VERIFICACIÓN DE FUNCIONAMIENTO INCLUIDA. COSTE DE RECICLAJE 5 €

## DE PELLETS AIRE CALIENTE

**Lira Slim Plus**

Potencia térmica hasta 6,4 kW. Permite calefactar estancias de hasta 46 m<sup>2</sup>. Panel de control digital incluido. Termostato y seguridad contra el retorno de la llama. Válvula antideflagración y presostato. Gran capacidad del contenedor de pellets: 12 kg.

Ferrolí  
ecoDESIGN



MODELO	POTENCIA NOMINAL	DIMENSIONES	RENDIMIENTO POTENCIA	CAPACIDAD PELLETS	CLASE ENERGÉTICA	REFERENCIA	PRECIO
LIRA SLIM PLUS	6,4 kW	760 x 400 x 430	89,90 %	12 kg	A+	OSS013XA	<b>1 545 €</b>

VERIFICACIÓN DE FUNCIONAMIENTO INCLUIDA. COSTE DE RECICLAJE 5 €

## Penelope HRN

Potencia térmica hasta 14,1 kW.  
Permite calefactar estancias de hasta 102 m<sup>2</sup>.  
Panel de control digital incluido.  
Termostato y seguridad contra el retorno de la llama.  
Válvula antideflagración y presostato.  
Gran capacidad del contenedor de pellets: 20 kg.

**ferrolì**  
ecoDESIGN



MODELO	POTENCIA NOMINAL	DIMENSIONES	RENDIMIENTO POTENCIA	CAPACIDAD PELLETS	CLASE ENERGÉTICA	REFERENCIA	PRECIO
*PENELOPE HRN	14,1 kW	981x 629 x 552	95,35 %	20 kg	A+	0SS083XA	<b>3 659 €</b>

VERIFICACIÓN DE FUNCIONAMIENTO INCLUIDA. COSTE DE RECICLAJE 5 € \*CONSULTAR STOCK

## Ecobel 8 kW

Potencia térmica hasta 8,2 kW.  
Permite calefactar estancias de hasta 200 m<sup>2</sup>.  
Panel de control digital incluido.  
Color disponible: Negro y Blanco.  
Bajo consumo y alto rendimiento.  
Gran capacidad del contenedor de pellets: 15 kg.

**METLOR**



MODELO	POTENCIA NOMINAL	DIMENSIONES	RENDIMIENTO POTENCIA	CAPACIDAD PELLETS	CLASE ENERGÉTICA	REFERENCIA	PRECIO
ECOBEL 8KW	8,2 kW	920 x 510 x 560	87 %	15 kg	A+	5600863308388	<b>1 190 €</b>

## Sun P7 N-P12

Quemador de pellets para adaptar calderas de carbón o leña.



MODELO	POTENCIA NOMINAL	DIMENSIONES	CONSUMO COMBUSTIBLE	CAPACIDAD DEPÓSITO	REFERENCIA	PRECIO
*P7N	33,44 kW	315 x 253 x 425	7,2 / 2,9 kg/h	195 L	55000077	<b>1 796 €</b>
*P12	55 kW	315 x 253 x 490	11,6 / 6,3 kg/h	393 L	550000127	<b>2 124 €</b>

\*CONSULTAR STOCK

## 04. Insertables

### DE LEÑA CON VENTILACIÓN

#### Elos 70

METLOR



Fabricado en chapa de acero al carbono.  
Cristal neocerámico de 4 mm de espesor y con una amplitud térmica de hasta 900°C.  
Todas las piezas inherentes al aparato son de acero.  
Equipado con 1 ventilador tangencial 285 x 50 mm con control on/off.  
Opción de 2 salidas de aire caliente de Ø 100 mm.  
Interior en vermiculita de 20 mm de espesor.

ecodesign

MODELO	POTENCIA NOMINAL	DIMENSIONES	RENDIMIENTO POTENCIA	LONGITUD LEÑA	CLASE ENERGÉTICA	REFERENCIA	PRECIO
*ELOS 70	7,8 kW	570 x 700 x 425	80,7 %	450 mm	A+	5600863307404	<b>1 040 €</b>

\*CONSULTAR STOCK

#### R8A

METLOR



Fabricado en chapa de acero al carbono.  
Cristal neocerámico de 4 mm de espesor y con una amplitud térmica de hasta 900°C.  
Todas las piezas inherentes al aparato son de acero.  
Equipado con 1 ventilador tangencial 285 x 50 mm con control on/off.  
Opción de 2 salidas de aire caliente de Ø 100 mm.  
Interior en vermiculita de 20 mm de espesor.

ecodesign

MODELO	POTENCIA NOMINAL	DIMENSIONES	RENDIMIENTO POTENCIA	LONGITUD LEÑA	CLASE ENERGÉTICA	REFERENCIA	PRECIO
*R8A	9,6 kW	545 x 685 x 400	80,7 %	450 mm	A+	5600863300382	<b>990 €</b>

\*CONSULTAR STOCK

### DE LEÑA HIDRO

#### Calefactor H 02/22

hergom



Hogar con frente en hierro fundido.  
Compatible con regulación electrónica.  
Regulación de aire primario.

ecodesign

MODELO	POTENCIA NOMINAL	DIMENSIONES	RENDIMIENTO POTENCIA	VOLUMEN	CLASE ENERGÉTICA	REFERENCIA	PRECIO
*H 02/22	15,4 kW	790 x 1172 x 527	86 %	52 L	A+	2020705	<b>Consultar</b>

\*CONSULTAR STOCK

## Llar S Vitrus Mini

Fabricado en chapa de acero al carbono.  
Con un espesor en la cámara de combustión de 5 mm.  
Cristal neocerámico de 4 mm de espesor  
y con una amplitud térmica de hasta 900°C.

METLOR

ecoDESIGN



MODELO	POTENCIA NOMINAL	DIMENSIONES	RENDIMIENTO POTENCIA	VOLUMEN	CLASE ENERGÉTICA	REFERENCIA	PRECIO
*LLAR S VITRUS MINI	16,4 kW	586 x 750 x 580	75 %	21 L	A	5600863306551	<b>1 470 €</b>

\*CONSULTAR STOCK

## Llar S, L, XL Eco

Fabricado en chapa de acero al carbono.  
Con un espesor en la cámara de combustión de 5 mm.  
Cristal neocerámico de 4 mm de espesor  
y con una amplitud térmica de hasta 900°C.

METLOR

ecoDESIGN



MODELO	POTENCIA NOMINAL	DIMENSIONES	RENDIMIENTO POTENCIA	VOLUMEN	CLASE ENERGÉTICA	REFERENCIA	PRECIO
*LLAR SECO MINI	16,4 kW	586 x 750 x 580	75 %	21 L	A	5600863306971	<b>1 365 €</b>
*LLAR L ECO	17,12 kW	570 x 750 x 580	80,3 %	50 L	A+	5600863303246	<b>1 630 €</b>
*LLAR XL ECO PLUS	25,06 kW	676 x 828 x 580	80,3 %	70 L	A+	5600863307497	<b>1 890 €</b>

\*CONSULTAR STOCK

## Sakan

Puerta, base y separador hogar de fundición.  
Palla de acero de 5 mm.

LACUNZA

ecoDESIGN



MODELO	POTENCIA NOMINAL	DIMENSIONES	RENDIMIENTO POTENCIA	LONGITUD LEÑA	CLASE ENERGÉTICA	REFERENCIA	PRECIO
*SAKAN 16	24,5 kW	700 x 990 x 486	80 %	500 mm	A+	303412100000	<b>2 386 €</b>
*SAKAN 20	25,5 kW	740 x 1 075 x 510	81 %	600 mm	A+	303452100000	<b>2 515 €</b>

\*CONSULTAR STOCK

## Sarria

Puerta, base y separador hogar de fundición.  
Paila de acero de 5 mm.



MODELO	POTENCIA NOMINAL	DIMENSIONES	RENDIMIENTO POTENCIA	LONGITUD LEÑA	CLASE ENERGÉTICA	REFERENCIA	PRECIO
*SARRIA 12 ECO	19 kW	700 x 740 x 486	80 %	21 L	A	303162100000	<b>1 744 €</b>
*SARRIA 16 ECO	24,5 kW	740 x 900 x 486	80 %	50 L	A+	303202100000	<b>2 265 €</b>
*SARRIA 20 ECO	25,5 kW	740 x 1 075 x 510	81 %	70 L	A+	303472100000	<b>2 381 €</b>

\*CONSULTAR STOCK

## DE PELLETS HIDRO

### Maxus Hidro

Salida de humos Ø 80 mm.



MODELO	POTENCIA NOMINAL	DIMENSIONES	RENDIMIENTO POTENCIA	CAPACIDAD PELLETS	CLASE ENERGÉTICA	REFERENCIA	PRECIO
*MAXUS HIDRO 20	17,93 kW	750 x 770 x 770	89,92 %	20 Kg	A+	5600863307374	<b>3 955 €</b>

\*CONSULTAR STOCK

### Maxus Vitrus

Salida de humos Ø 80 mm.



MODELO	POTENCIA NOMINAL	DIMENSIONES	RENDIMIENTO POTENCIA	CAPACIDAD PELLETS	CLASE ENERGÉTICA	REFERENCIA	PRECIO
*MAXUS VITRUS	11,2 kW	650 x 775 x 670	91 %	13 Kg	A+	5600863307350	<b>2 705 €</b>

\*CONSULTAR STOCK

## 05. Cocinas de Leña

### Etna 7T E SH

Cocina cerrada (modular) con estructura de acero.  
Puertas y manillas de acero inoxidable.  
Amplia visión de fuego gracias a su gran cristal en el hogar.  
Herrajes cromados y horno de acero inoxidable con escotilla de limpieza.  
Encimera tradicional de hierro fundido con arandelas.  
Opción de vitroceramica elevable.  
Sistema de doble combustión.



MODELO	POTENCIA NOMINAL	DIMENSIONES	RENDIMIENTO POTENCIA	LONGITUD LEÑA	CLASE ENERGÉTICA	REFERENCIA	PRECIO
*ETNA 7T E SH	17 kW	900 x 900 x 600	82 %	400 mm	A+	3013920127	<b>3 158 €</b>

\*CONSULTAR STOCK

### Vulcano 7T E5 SV

Cocina cerrada (modular) fabricada en hierro fundido.  
Doble cristal en la puerta de hogar y control de tiro termostático.  
Herrajes cromados y horno de acero inoxidable.  
Escotilla de limpieza y extracción de vahos de serie.  
Gran encimera vitrocerámica elevable.  
Plancha inferior de hierro fundido.  
Que permite cocinar a la plancha sobre ella.



MODELO	POTENCIA NOMINAL	DIMENSIONES	RENDIMIENTO POTENCIA	LONGITUD LEÑA	CLASE ENERGÉTICA	REFERENCIA	PRECIO
*VULCANO 7T E5 SV	30,5 kW	900 x 900 x 600	84 %	500 mm	A+	301312511400	<b>5 383 €</b>

\*CONSULTAR STOCK

## 06. Calderas Murales



### Condens GC2300i W



MODELO / REFERENCIA	GAS	POTENCIA (CAL / ACS)	DIMENSIONES	CLASE ENERGÉTICA	PRECIO
GC2300i W 24/30 - 7 736 902330	Pro	24/30,6 kW	710 x 400 x 300	A	<b>1 720 €</b>
GC2300i W 24/30 - 7 736 902329	Nat	24/30,6 kW	710 x 400 x 300	A	<b>1 720 €</b>



### Condens GC4300i W



MODELO / REFERENCIA	GAS	POTENCIA (CAL / ACS)	DIMENSIONES	CLASE ENERGÉTICA	PRECIO
GC4300i W 24/25 - 7 731 200 603	Pro	24/25 kW	710 x 400 x 300	A	<b>2 245 €</b>
GC4300i W 24/25 - 7 731 200 602	Nat	24/25 kW	710 x 400 x 300	A	<b>2 245 €</b>
GC4300i W 24/30 - 7 731 200 601	Pro	24/30 kW	710 x 400 x 300	A	<b>2 575 €</b>
GC4300i W 24/30 - 7 731 200 600	Nat	24/30 kW	710 x 400 x 300	A	<b>2 575 €</b>
GC4300i W P 24 - 7 731 200 607	Nat	24/- kW	710 x 400 x 300	A	<b>2 195 €</b>



### Gaz Star GS3000 (Atmosférica)



MODELO / REFERENCIA	GAS	POTENCIA (CAL / ACS)	DIMENSIONES	CLASE ENERGÉTICA	PRECIO
GS300W 24C 23 - 7 731 200 620	Nat	24/24 kW	865 x 400 x 385	C/B	<b>1 525 €</b>



### Kalis

MODELO / REFERENCIA	GAS	POTENCIA (CAL / ACS)	DIMENSIONES	CLASE ENERGÉTICA	PRECIO
24 C - 695W00244	P/N	20,6/25 kW	700 x 420 x 250	A	<b>2 168 €</b>



### Bluehelix Alpha

MODELO / REFERENCIA	GAS	POTENCIA (CAL / ACS)	DIMENSIONES	CLASE ENERGÉTICA	PRECIO
28 C N/P - 695L00284	P/N	24/28,5 kW	700 x 420 x 250	A	<b>2 518 €</b>
34 C N/P - 695L00344	P/N	30/34,5 kW	700 x 420 x 320	A	<b>2 804 €</b>



### Ecotec Plus Incluye control SensoHome Radio

MODELO / REFERENCIA	GAS	POTENCIA (CAL / ACS)	DIMENSIONES	CLASE ENERGÉTICA	PRECIO
VMW 26CS/1-5Cf - 8000014271	P/N	19,7/25,7 kW	720 x 440 x 338	A	<b>3 180 €</b>
VMW 32CS/1-5Cf - 8000014256	P/N	25/31,8 kW	720 x 440 x 338	A	<b>3 840 €</b>



### Ecotec Pure

MODELO / REFERENCIA	GAS	POTENCIA (CAL / ACS)	DIMENSIONES	CLASE ENERGÉTICA	PRECIO
VMW 236/7-2 - 2519977	P/N	18,5/24 kW	720 x 440 x 334	A	<b>2 580 €</b>
VMW 286/7-2 - 2519978	P/N	24/28 kW	720 x 440 x 334	A	<b>2 760 €</b>



### Alteas ONE+ Net

MODELO / REFERENCIA	GAS	POTENCIA (CAL / ACS)	DIMENSIONES	CLASE ENERGÉTICA	PRECIO
24 FF EU - 3301771	P/N	22/26 kW	745 x 400 x 315	A	<b>2 882 €</b>
30 FF EU - 3301772	P/N	28/30 kW	745 x 400 x 385	A	<b>3 056 €</b>
35 FF EU - 3301773	P/N	31/34,5 kW	745 x 400 x 385	A	<b>3 312 €</b>

\*KIT 3 grifos (opcional) - REF.: 3318285 - **44 €** | \*KIT evacuación (incluido) 60/100 mm - REF.: 3318073 - **44 €**



### Genus ONE+ WiFi

MODELO / REFERENCIA	GAS	POTENCIA (CAL / ACS)	DIMENSIONES	CLASE ENERGÉTICA	PRECIO
24 FF EU - 3301777	P/N	22/26 kW	745 x 400 x 315	A	<b>2 428 €</b>
30 FF EU - 3301778	P/N	28/30 kW	745 x 400 x 385	A	<b>2 700 €</b>
35 FF EU - 3301779	P/N	31/34,5 kW	745 x 400 x 385	A	<b>2 939 €</b>

\*KIT 3 grifos (opcional) - REF.: 3318285 - **44 €** | \*KIT evacuación (incluido) 60/100 mm - REF.: 3318073 - **44 €**



### Clas ONE WiFi

MODELO / REFERENCIA	GAS	POTENCIA (CAL / ACS)	DIMENSIONES	CLASE ENERGÉTICA	PRECIO
24 FF EU - 3302123	P/N	22/26 kW	745 x 400 x 315	A	<b>2 105 €</b>
30 FF EU - 3302124	P/N	28/30 kW	745 x 400 x 385	A	<b>2 377 €</b>
35 FF EU - 3302125	P/N	31/34,5 kW	745 x 400 x 385	A	<b>2 760 €</b>

\*KIT 3 grifos (opcional) - REF.: 3318285 - **44 €** | \*KIT evacuación (incluido) 60/100 mm - REF.: 3318073 - **44 €**



### Cares S

MODELO / REFERENCIA	GAS	POTENCIA (CAL / ACS)	DIMENSIONES	CLASE ENERGÉTICA	PRECIO
24 - 3301637	P/N	20/23,5 kW	745 x 400 x 319	A	<b>1 813 €</b>
30 - 3301638	P/N	24/29 kW	745 x 400 x 319	A	<b>2 047 €</b>

\*KIT 3 grifos (opcional) - REF.: 3318285 - **44 €** | \*KIT evacuación (incluido) 60/100 mm - REF.: 3318073 - **44 €**



02

**Emisores**



## RD

REFERENCIA	DISTANCIA EJES	ALTO	ANCHO	FONDO	KCAL/H - $\Delta T$ 50°	KCAL/H - $\Delta T$ 30°	PRECIO
RD 350	260 mm	340	80	96	62,09	-	<b>22,10 €</b>
RD 425	350 mm	430	80	96	79,89	-	<b>20,21 €</b>
RD 600	500 mm	580	80	96	107,50	-	<b>19,45 €</b>
RD 700	600 mm	680	80	96	125,56	-	<b>24,67 €</b>
RD 800	700 mm	799	80	96	141,04	-	<b>27,86 €</b>



## Magno

REFERENCIA	DISTANCIA EJES	ALTO	ANCHO	FONDO	KCAL/H - $\Delta T$ 50°	KCAL/H - $\Delta T$ 30°	PRECIO
MAGNO 350	260 mm	350	80	95	65,10	-	<b>14,60 €</b>
MAGNO 425	350 mm	425	80	95	82,90	-	<b>15,03 €</b>
MAGNO 600	500 mm	580	80	95	108,36	-	<b>16,32 €</b>
MAGNO 700	600 mm	680	80	95	124,70	-	<b>18,91 €</b>
MAGNO 800	700 mm	780	80	95	141,04	-	<b>20,94 €</b>



### Vox Extra



REFERENCIA	DISTANCIA EJES	ALTO	ANCHO	FONDO	KCAL/H - ΔT 50°	KCAL/H - ΔT 30°	PRECIO
VOX EXTRA 600 / GVOX6000	600 mm	677	80	95	118	61	<b>15,98 €</b>



### Xian N



REFERENCIA	DISTANCIA EJES	ALTO	ANCHO	FONDO	KCAL/H - ΔT 50°	KCAL/H - ΔT 30°	PRECIO
XIAN 450N / 739043001	350 mm	431	80	100	78	40,08	<b>26,01 €</b>
XIAN 600N / 739058001	500 mm	581	80	100	105,7	53,4	<b>26,17 €</b>
XIAN 700N / 739068001	600 mm	681	80	100	122,3	61,9	<b>32,27 €</b>
XIAN 800N / 739078001	700 mm	781	80	100	137,7	69,7	<b>36,37 €</b>



### Europa



REFERENCIA	DISTANCIA EJES	ALTO	ANCHO	FONDO	KCAL/H - ΔT 50°	KCAL/H - ΔT 30°	PRECIO
EUROPA 450C / 740043001	350 mm	431	80	100	76,7	39,96	<b>26,05 €</b>
EUROPA 600C / 740058001	500 mm	581	80	100	103,0	52,52	<b>26,22 €</b>
EUROPA 700C / 740068001	600 mm	681	80	100	117,9	60,19	<b>32,35 €</b>
EUROPA 800C / 740078001	700 mm	781	80	100	135,8	69,19	<b>36,45 €</b>

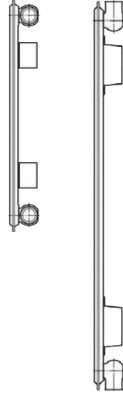

**Simple Modelo 10 3**  
Altura 300 mm

REFERENCIA	DIMENSIONES	KCAL/H	PRECIO
1660	400 mm	120	<b>18,30 €</b>
1661	520 mm	156	<b>23,88 €</b>
1662	600 mm	180	<b>27,53 €</b>
1663	720 mm	216	<b>33,03 €</b>
1664	800 mm	240	<b>36,63 €</b>
1665	920 mm	276	<b>42,18 €</b>
1666	1 000 mm	300	<b>54,96 €</b>
1667	1 120 mm	336	<b>61,62 €</b>
1668	1 200 mm	359	<b>66,06 €</b>
1669	1 320 mm	395	<b>72,57 €</b>
1670	1 400 mm	419	<b>77,01 €</b>
1671	1 600 mm	479	<b>88,08 €</b>
1672	1 800 mm	539	<b>115,47 €</b>
1673	2 000 mm	598	<b>128,45 €</b>
1674	2 200 mm	658	<b>141,26 €</b>
1675	2 400 mm	718	<b>153,97 €</b>
1676	2 600 mm	778	<b>166,95 €</b>
1677	2 800 mm	837	<b>179,66 €</b>
1678	3 000 mm	897	<b>192,54 €</b>

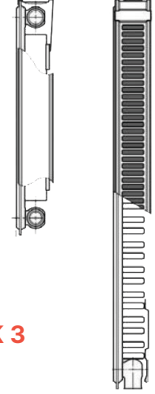

**Simple Convector Modelo 11K 3**  
Altura 300 mm

REFERENCIA	DIMENSIONES	KCAL/H	PRECIO
3520	400 mm	195	<b>29,78 €</b>
3521	520 mm	253	<b>38,75 €</b>
3522	600 mm	292	<b>44,70 €</b>
3523	720 mm	351	<b>53,63 €</b>
3524	800 mm	389	<b>59,50 €</b>
3525	920 mm	448	<b>68,45 €</b>
3526	1 000 mm	486	<b>89,28 €</b>
3527	1 120 mm	545	<b>100,08 €</b>
3528	1 200 mm	584	<b>107,19 €</b>
3529	1 320 mm	642	<b>117,93 €</b>
3530	1 400 mm	681	<b>125,07 €</b>
3531	1 600 mm	778	<b>142,92 €</b>
3532	1 800 mm	875	<b>187,64 €</b>
3533	2 000 mm	972	<b>208,36 €</b>
3534	2 200 mm	1 069	<b>229,22 €</b>
3535	2 400 mm	1 167	<b>250,08 €</b>
3536	2 600 mm	1 264	<b>270,94 €</b>
3537	2 800 mm	1 361	<b>291,76 €</b>
3538	3 000 mm	1 485	<b>312,62 €</b>

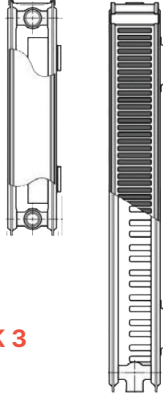

**Doble Convector Modelo 21K 3**  
**Altura 300 mm**

REFERENCIA	DIMENSIONES	KCAL/H	PRECIO
3634	400 mm	289	<b>44,15 €</b>
3635	520 mm	375	<b>57,43 €</b>
3636	600 mm	433	<b>66,25 €</b>
3637	720 mm	519	<b>79,45 €</b>
3638	800 mm	577	<b>88,25 €</b>
3639	920 mm	664	<b>101,58 €</b>
3640	1 000 mm	721	<b>132,51 €</b>
3641	1 120 mm	807	<b>148,41 €</b>
3642	1 200 mm	865	<b>159,00 €</b>
3643	1 320 mm	952	<b>174,84 €</b>
3644	1 400 mm	1 009	<b>185,46 €</b>
3645	1 600 mm	1 153	<b>211,98 €</b>
3646	1 800 mm	1 297	<b>278,11 €</b>
3647	2 000 mm	1 441	<b>309,12 €</b>
3648	2 200 mm	1 585	<b>340,06 €</b>
3649	2 400 mm	1 729	<b>370,90 €</b>
3650	2 600 mm	1 874	<b>401,87 €</b>
3651	2 800 mm	2 017	<b>432,60 €</b>
3652	3 000 mm	2 162	<b>463,68 €</b>

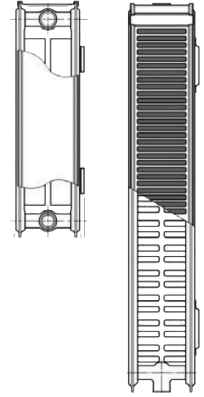

**Doble 2 Conectores**  
**Modelo 22K 3**  
**Altura 300 mm**

REFERENCIA	DIMENSIONES	KCAL/H	PRECIO
3748	400 mm	377	<b>57,70 €</b>
3749	520 mm	491	<b>74,98 €</b>
3750	600 mm	566	<b>86,55 €</b>
3751	720 mm	679	<b>103,78 €</b>
3752	800 mm	754	<b>115,38 €</b>
3753	920 mm	867	<b>132,70 €</b>
3754	1 000 mm	942	<b>173,16 €</b>
3755	1 120 mm	1 056	<b>193,80 €</b>
3756	1 200 mm	1 131	<b>207,75 €</b>
3757	1 320 mm	1 244	<b>228,42 €</b>
3758	1 400 mm	1 319	<b>242,31 €</b>
3759	1 600 mm	1 507	<b>276,99 €</b>
3760	1 800 mm	1 696	<b>363,51 €</b>
3761	2 000 mm	1 884	<b>403,87 €</b>
3762	2 200 mm	2 072	<b>444,33 €</b>
3763	2 400 mm	2 261	<b>484,65 €</b>
3764	2 600 mm	2 449	<b>525,07 €</b>
3765	2 800 mm	2 637	<b>565,50 €</b>
3766	3 000 mm	2 826	<b>605,85 €</b>

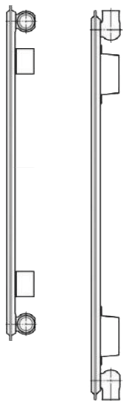

**Simple Modelo 10 6**  
**Altura 600 mm**

REFERENCIA	DIMENSIONES	KCAL/H	PRECIO
1717	400 mm	215	<b>32,93 €</b>
1718	520 mm	280	<b>42,80 €</b>
1719	600 mm	323	<b>49,40 €</b>
1720	720 mm	387	<b>59,30 €</b>
1721	800 mm	430	<b>65,88 €</b>
1722	920 mm	495	<b>75,78 €</b>
1723	1 000 mm	538	<b>98,79 €</b>
1724	1 120 mm	602	<b>110,61 €</b>
1725	1 200 mm	645	<b>118,53 €</b>
1726	1 320 mm	710	<b>130,41 €</b>
1727	1 400 mm	753	<b>138,30 €</b>
1728	1 600 mm	860	<b>158,10 €</b>
1729	1 800 mm	968	<b>207,45 €</b>
1730	2 000 mm	1 075	<b>230,58 €</b>
1731	2 200 mm	1 183	<b>253,61 €</b>
1732	2 400 mm	1 290	<b>276,64 €</b>
1733	2 600 mm	1 398	<b>299,74 €</b>
1734	2 800 mm	1 505	<b>322,70 €</b>
1735	3 000 mm	1 613	<b>345,77 €</b>

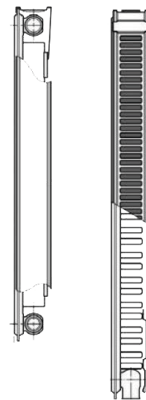

**Simple Convector**  
**Modelo 11K 6**  
**Altura 600 mm**

REFERENCIA	DIMENSIONES	KCAL/H	PRECIO
3577	400 mm	324	<b>51,13 €</b>
3578	520 mm	421	<b>66,53 €</b>
3579	600 mm	486	<b>76,83 €</b>
3580	720 mm	583	<b>92,08 €</b>
3581	800 mm	647	<b>102,38 €</b>
3582	920 mm	744	<b>117,68 €</b>
3583	1 000 mm	809	<b>153,54 €</b>
3584	1 120 mm	906	<b>171,99 €</b>
3585	1 200 mm	971	<b>184,14 €</b>
3586	1 320 mm	1 068	<b>202,68 €</b>
3587	1 400 mm	1 132	<b>214,83 €</b>
3588	1 600 mm	1 294	<b>245,58 €</b>
3589	1 800 mm	1 456	<b>322,32 €</b>
3590	2 000 mm	1 617	<b>358,09 €</b>
3591	2 200 mm	1 779	<b>393,93 €</b>
3592	2 400 mm	1 941	<b>429,70 €</b>
3593	2 600 mm	2 102	<b>465,68 €</b>
3594	2 800 mm	2 264	<b>501,41 €</b>
3595	3 000 mm	2 426	<b>537,29 €</b>

**Doble Convector  
Modelo 21K 6  
Altura 600 mm**

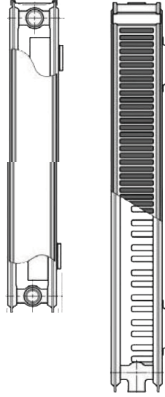

REFERENCIA	DIMENSIONES	KCAL/H	PRECIO
3691	400 mm	467	<b>75,10 €</b>
3692	520 mm	608	<b>97,63 €</b>
3693	600 mm	701	<b>112,63 €</b>
3694	720 mm	842	<b>135,13 €</b>
3695	800 mm	934	<b>150,15 €</b>
3696	920 mm	1 075	<b>172,70 €</b>
3697	1 000 mm	1 168	<b>225,30 €</b>
3698	1 120 mm	1 309	<b>252,30 €</b>
3699	1 200 mm	1 401	<b>270,33 €</b>
3700	1 320 mm	1 542	<b>297,33 €</b>
3701	1 400 mm	1 635	<b>315,39 €</b>
3702	1 600 mm	1 868	<b>360,42 €</b>
3703	1 800 mm	2 102	<b>473,10 €</b>
3704	2 000 mm	2 335	<b>525,63 €</b>
3705	2 200 mm	2 569	<b>578,17 €</b>
3706	2 400 mm	2 802	<b>630,74 €</b>
3707	2 600 mm	3 036	<b>683,34 €</b>
3708	2 800 mm	3 269	<b>735,88 €</b>
3709	3 000 mm	3 503	<b>788,38 €</b>

**Doble 2 Conectores  
Modelo 22K 6  
Altura 600 mm**

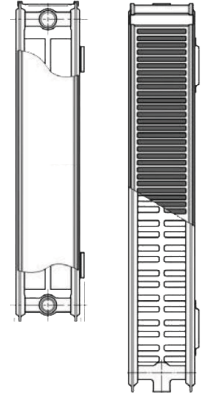

REFERENCIA	DIMENSIONES	KCAL/H	PRECIO
3805	400 mm	590	<b>96,15 €</b>
3806	520 mm	767	<b>125,18 €</b>
3807	600 mm	885	<b>144,40 €</b>
3808	720 mm	1 061	<b>173,25 €</b>
3809	800 mm	1 179	<b>192,43 €</b>
3810	920 mm	1 356	<b>221,35 €</b>
3811	1 000 mm	1 474	<b>288,69 €</b>
3812	1 120 mm	1 650	<b>323,31 €</b>
3813	1 200 mm	1 768	<b>346,35 €</b>
3814	1 320 mm	1 945	<b>381,00 €</b>
3815	1 400 mm	2 063	<b>404,04 €</b>
3816	1 600 mm	2 357	<b>461,94 €</b>
3817	1 800 mm	2 652	<b>606,20 €</b>
3818	2 000 mm	2 946	<b>673,58 €</b>
3819	2 200 mm	3 241	<b>740,78 €</b>
3820	2 400 mm	3 535	<b>808,19 €</b>
3821	2 600 mm	3 830	<b>875,70 €</b>
3822	2 800 mm	4 124	<b>942,94 €</b>
3823	3 000 mm	4 419	<b>1 010,31 €</b>

# 02 Emisores

## 03. Toalleros Hidráulicos

### Zehnder Aura Agua Caliente

Instalación flexible gracias a la posibilidad de conexión a la derecha y a la izquierda. Se suministra con accesorio de conexión Zehnder Vario para una técnica de conexión oculta discreta y elegante.

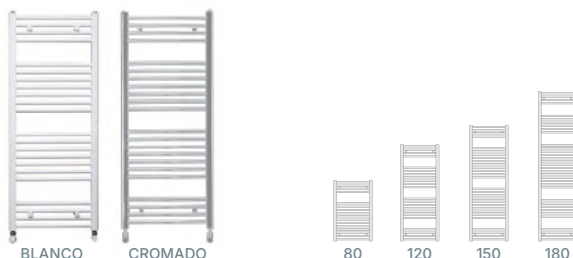

REFERENCIA BLANCO	REFERENCIA CROMADO	DIMENSIONES	DISTANCIA ENTRE EJES	POTENCIA BLANCO	POTENCIA CROMADO	PRECIO BLANCO	PRECIO CROMADO
PBN-080-045	PBCN-080-045	775 x 450 mm	400 mm	326 W	206 W	127,77 €	266,48 €
PBN-080-050	PBCN-080-050	775 x 500 mm	450 mm	257 W	229 W	132,72 €	270,58 €
PBN-080-055	-	775 x 550 mm	500 mm	359 W	-	137,20 €	-
PBN-080-060	*PBCN-080-060	775 x 600 mm	550 mm	420 W	327 W	140,18 €	273,34 €
PBN-120-045	PBCN-120-045	1 217 x 450 mm	400 mm	469 W	303 W	186,78 €	332,80 €
PBN-120-050	PBCN-120-050	1 217 x 500 mm	450 mm	511 W	331 W	189,65 €	350,76 €
PBN-120-055	-	1 217 x 550 mm	500 mm	553 W	-	196,01 €	-
PBN-120-060	PBCN-120-060	1 217 x 600 mm	550 mm	595 W	473 W	204,31 €	354,37 €
PBN-150-045	-	1 469 x 450 mm	400 mm	576 W	-	245,87 €	-
PBN-150-050	PBCN-150-050	1 469 x 500 mm	450 mm	629 W	406 W	251,35 €	510,96 €
PBN-150-055	*PBCN-150-055	1 469 x 550 mm	500 mm	638 W	443 W	258,85 €	519,19 €
PBN-150-060	*PBCN-150-060	1 469 x 600 mm	550 mm	794 W	580 W	262,34 €	527,43 €
PBN-180-050	PBCN-180-050	1 856 x 500 mm	450 mm	786 W	514 W	299,43 €	638,70 €
*PBN-180-055	*PBCN-180-055	1 856 x 550 mm	500 mm	904 W	559 W	314,53 €	652,43 €
PBN-180-060	*PBCN-180-060	1 856 x 600 mm	550 mm	978 W	714 W	331,01 €	668,16 €

\*CONSULTAR STOCK

### Zeta X Agua Caliente

Material: Acero  
Garantía: 10 años



REFERENCIA BLANCO	REFERENCIA CROMADO	DIMENSIONES	DISTANCIA ENTRE EJES	POTENCIA	PRECIO BLANCO	PRECIO CROMADO
9108400	*9108401	770 x 450 mm	400 mm	276 W	92 €	174 €
9108450	*9108451	770 x 500 mm	450 mm	299 W	96 €	187 €
9108500	*9108501	770 x 550 mm	500 mm	322 W	98 €	191 €
*9112400	*9112401	1 120 x 450 mm	400 mm	422 W	148 €	225 €
9112450	*9112451	1 120 x 500 mm	450 mm	459 W	146 €	228 €
*9112500	*9112501	1 120 x 550 mm	500 mm	495 W	150 €	231 €

\*CONSULTAR STOCK

## Zeta T Agua Caliente

Material: Acero lacado blanco  
Garantía: 10 años

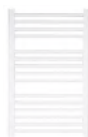

Zeta  
COLLECTION

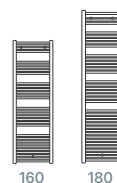

REFERENCIA	DIMENSIONES	DISTANCIA ENTRE EJES	POTENCIA	PRECIO CROMADO
*9108350	800 x 400 mm	350 mm	323 W	<b>102 €</b>
*9108550	800 x 600 mm	550 mm	476 W	<b>113 €</b>
*9115400	1 600 x 450 mm	400 mm	723 W	<b>245 €</b>
9115450	1 600 x 500 mm	450 mm	792 W	<b>251 €</b>
9115500	1 600 x 550 mm	500 mm	864 W	<b>254 €</b>
9115550	1 600 x 600 mm	550 mm	935 W	<b>267 €</b>
9118400	1 800 x 450 mm	400 mm	880 W	<b>259 €</b>
9117450	1 800 x 500 mm	450 mm	970 W	<b>265 €</b>
*9117500	1 800 x 550 mm	500 mm	1 066 W	<b>269 €</b>
*9118550	1 800 x 600 mm	550 mm	1 155 W	<b>274 €</b>

\*CONSULTAR STOCK

## Zeta X Agua Caliente

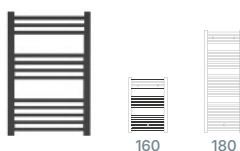

REFERENCIA	DIMENSIONES	DISTANCIA ENTRE EJES	POTENCIA	PRECIO
ZXN770500	770 x 500 mm	450 mm	299 W	<b>124 €</b>
*ZXN112050	1120 x 450 mm	400 mm	422 W	<b>178 €</b>

\*CONSULTAR STOCK

## Kit Válvula + Detentor



REFERENCIA	MEDIDA	PRECIO
V1306H	Blanco	<b>46,20 €</b>
V13060B	Cromado	<b>46,20 €</b>
V1406NE	Negro	<b>46,20 €</b>

RACOR COBRE 15 + MULTICAPA 16

## 04. Toalleros Eléctricos

### Zehnder Aura Eléctrico

Incluyen termostato ambiente y termostato interno de seguridad.  
Incluye todos los accesorios para su instalación.



REFERENCIA BLANCO	REFERENCIA CROMADO	DIMENSIONES	POTENCIA BLANCO	POTENCIA CROMADO	PRECIO BLANCO	PRECIO CROMADO
PBEZ-080-40	PBECZ-080-40	860 x 400 mm	300 W	150 W	<b>289,82 €</b>	<b>402,44 €</b>
PBEZ-120-50	PBECZ-120-50	1300 x 500 mm	750 W	300 W	<b>410,68 €</b>	<b>535,43 €</b>
PBEZ-150-50	PBECZ-150-60	1540 x 500/600 mm	750 W	400 W	<b>513,70 €</b>	<b>629,07 €</b>



# ACS y Acumulación

# 03

### Andris R



MODELO / REFERENCIA	POTENCIA	DIMENSIONES	CLASE ENERGÉTICA	PRECIO
15 OR EU - 3100332	1 200 W	360 x 360 x 324	A	<b>234,84 €</b>
30 OR EU - 3100337	1 500 W	447 x 447 x 389	C	<b>271,32 €</b>

### Lydos Eco



MODELO / REFERENCIA	POTENCIA	DIMENSIONES	CLASE ENERGÉTICA	PRECIO
50 V EU - 3201863	1 500 W	528 x 450 x 470	B	<b>339,72 €</b>
80 V EU - 3201864	1 500 W	733 x 450 x 470	B	<b>395,58 €</b>
100 V EU - 3201865	1 500 W	885 x 450 x 470	B	<b>434,34 €</b>

### Lydos Hybrid WiFi



MODELO / REFERENCIA	POTENCIA	DIMENSIONES	CLASE ENERGÉTICA	PRECIO
80 - 3629064	1 200 W	1 009 x 465 x 465	A	<b>980,40 €</b>
100 - 3629065	1 200 W	1 153 x 465 x 465	A	<b>1 046,52 €</b>

### Pro 1R



MODELO / REFERENCIA	POTENCIA	DIMENSIONES	CLASE ENERGÉTICA	PRECIO
50 V ES EU - 3201926	1 500 W	573 x 450 x 480	C	<b>265,62 €</b>
80 V ES EU - 3201927	1 500 W	778 x 450 x 480	C	<b>306,66 €</b>
100 V ES EU - 3201928	1 500 W	918 x 450 x 480	C	<b>340,86 €</b>



### Pro B STI



MODELO / REFERENCIA	POTENCIA	DIMENSIONES	CLASE ENERGÉTICA	PRECIO
500 STI EU - 3070544	6 000 W	1 937 x 751 x 860	C	<b>2 937,78 €</b>



### Pro Zen



MODELO / REFERENCIA	POTENCIA	DIMENSIONES	CLASE ENERGÉTICA	PRECIO
150V EU - 3000324	1 800 W	1 160 x 530 x 545	C	<b>793,44 €</b>
200V EU - 3000349	2 400 W	1 463 x 530 x 545	C	<b>906,30 €</b>
300 ST EU - 3000685	3 000 W	1 970 x 570 x 630	C	<b>1 340,64 €</b>



### Pro 1 Eco Dry Multis



MODELO / REFERENCIA	POTENCIA	DIMENSIONES	CLASE ENERGÉTICA	PRECIO
30 SLIM EU - 3626464	1 600 (2 x 800) W	588 x 353 x 373	A	<b>418,38 €</b>
50 SLIM EU - 3626465	1 800 (2 x 900) W	837 x 353 x 373	B	<b>437,76 €</b>
80 EU - 3201998	1 800 (2 x 900) W	758 x 450 x 470	B	<b>484,50 €</b>
100 EU - 3201999	1 800 (2 x 900) W	913 x 450 x 470	B	<b>533,52 €</b>



### Pro 1 Eco H



MODELO / REFERENCIA	POTENCIA	DIMENSIONES	CLASE ENERGÉTICA	PRECIO
80 H EU - 3201955	1 500 W	450 x 758 x 470	B	<b>395,58 €</b>
100 H EU - 3201952	1 500 W	450 x 913 x 470	B	<b>434,34 €</b>



### Pro B V/H

MODELO / REFERENCIA	POTENCIA	DIMENSIONES	CLASE ENERGÉTICA	PRECIO
150 V EU - 3000361	1 800 W	1 020 x 560 x 575	C	<b>680,58 €</b>
200 V EU - 3000362	2 200 W	1 280 x 560 x 575	C	<b>748,98 €</b>
150 H EU - 3010896	2 000 W	570 x 1 020 x 585	C	<b>680,58 €</b>
200 H EU - 3010900	2 000 W	570 x 1 290 x 585	C	<b>748,98 €</b>



### Fleck Bon

MODELO / REFERENCIA	POTENCIA	DIMENSIONES	CLASE ENERGÉTICA	PRECIO
50 EU - 3201679	1 200 W	855 x 353 x 380	B	<b>467,00 €</b>
75 EU - 3201680	1 500 W	950 x 413 x 430	B	<b>569,00 €</b>
100 EU - 3201681	1 500 W	1 210 x 414 x 430	C	<b>616,00 €</b>



### Fleck Nilo

MODELO / REFERENCIA	POTENCIA	DIMENSIONES	CLASE ENERGÉTICA	PRECIO
150 EU - 3201687	2 500 W	1 190 x 513 x 550	C	<b>1 125,18 €</b>
200 EU - 3201688	2 500 W	1 490 x 513 x 550	C	<b>1 283,64 €</b>



### Velis Pro WiFi

MODELO / REFERENCIA	POTENCIA	DIMENSIONES	CLASE ENERGÉTICA	PRECIO
30 ES EU - 3626360	2 x 1 500 W	557 x 511 x 275	A	<b>410,00 €</b>
50 ES EU - 3626361	2 x 1 500 W	797 x 511 x 275	B	<b>477,00 €</b>
80 ES EU - 3626362	2 x 1 500 W	1 087 x 511 x 275	B	<b>580,00 €</b>
100 ES EU - 3626366	2 x 1 500 W	1 272 x 511 x 275	B	<b>647,00 €</b>



### Velis Tech Dry Wifi

ARISTON

MODELO / REFERENCIA	POTENCIA	DIMENSIONES	CLASE ENERGÉTICA	PRECIO
50 ES EU - 3100924	2 x 1 500 W	797 x 511 x 275	B	<b>648,66 €</b>
80 ES EU - 3100925	2 x 1 500 W	1 087 x 511 x 275	B	<b>788,88 €</b>
100 ES EU - 3100926	2 x 1 500 W	1 272 x 511 x 275	B	<b>878,94 €</b>



### Te Rigid (Inox)

valinox

MODELO / REFERENCIA	POTENCIA	DIMENSIONES	CLASE ENERGÉTICA	PRECIO
50 L - 00453600MV	1 500 W	700 x 500	B	<b>660 €</b>
80 L - 00453601MV	1 500 W	900 x 500	B	<b>700 €</b>
100 L - 00453602MV	1 800 W	1 100 x 500	B	<b>800 €</b>
150 L - 00453604MV	2 400 W	1 050 x 600	B	<b>880 €</b>
200 L - 00453605P	3 000 W	1 350 x 600	B	<b>1 050 €</b>



### E20 DP/ \*E20

COBALLES

MODELO / REFERENCIA	POTENCIA	DIMENSIONES	CLASE ENERGÉTICA	PRECIO
50 L - 3021100050	1 200 W	790 x 420	B	<b>812 €</b>
80 L - 3021100080	1 200 W	1 030 x 420	B	<b>889 €</b>
100 L - 3021100100	1 200 W	1 230 x 420	B	<b>915 €</b>
150 L - 3031100150	2 400 W	1 300 x 530	C	<b>1 120 €</b>
200 L - 3031100200	2 400 W	1 315 x 600	C	<b>1 375 €</b>
300 L - *3030110300	2 400 W	1 845 x 600	D	<b>1 890 €</b>

### Interacumulador VTCE Rigid



MODELO / REFERENCIA	VOLUMEN	DIMENSIONES	CLASE ENERGÉTICA	PRECIO
RIGID - 00353602PM	100 L	1 050 x 500	A	<b>720 €</b>
RIGID - 00353604PM	150 L	1 020 x 600	B	<b>840 €</b>
RIGID - 00353605PM	200 L	1 300 x 600	B	<b>1 090 €</b>
RIGID - 00353607P	300 L	1 800 x 600	B	<b>1 315 €</b>
RIGID - 00353609P	500 L	2 000 x 720	C	<b>2 250 €</b>

### Interacumulador VTCE-HL Serpentín Bomba de Calor



MODELO / REFERENCIA	VOLUMEN	DIMENSIONES	CLASE ENERGÉTICA	PRECIO
RIGID - 003536604PM_HL	150 L	1 020 x 600	B	<b>1 100 €</b>
RIGID - 00353605PM_HL	200 L	1 300 x 600	B	<b>1 350 €</b>
RIGID - 00353607P_HL	300 L	1 800 x 600	B	<b>1 550 €</b>
RIGID - 00353609P_HL	500 L	2 000 x 720	C	<b>2 530 €</b>

### Interacumulador CCE Doble Cuerpo



MODELO / REFERENCIA	VOLUMEN	DIMENSIONES	CLASE ENERGÉTICA	PRECIO
RIGID - 00153602M	100 L	1 050 x 500	A	<b>810 €</b>
RIGID - 00153604M	150 L	1 020 x 600	B	<b>960 €</b>
RIGID - 00153605M	200 L	1 300 x 600	B	<b>1 130 €</b>
RIGID - 00153607P	300 L	1 800 x 600	C	<b>1 630 €</b>

### Interacumulador VTCE Serpentín



MODELO / REFERENCIA	VOLUMEN	DIMENSIONES	CLASE ENERGÉTICA	PRECIO
CLOTH - 00352602PM	100 L	1 030 x 480	C	<b>Consultar</b>
CLOTH - 00352604PM	150 L	1 000 x 580	C	<b>Consultar</b>
CLOTH - 00352605PM	200 L	1 280 x 580	C	<b>Consultar</b>
CLOTH - 00352607P	300 L	1 800 x 580	D	<b>Consultar</b>



## Interacumulador 2VTCE Doble Serpentin

MODELO / REFERENCIA	VOLUMEN	DIMENSIONES	CLASE ENERGÉTICA	PRECIO
RIGID - 00753602PM	100 L	1 030 x 480	C	<b>840 €</b>
RIGID - 00753604PM	150 L	1 000 x 580	C	<b>1 025 €</b>
RIGID - 00753605PM	200 L	1 300 x 580	C	<b>1 080 €</b>
RIGID - 00753607P	300 L	1 800 x 580	D	<b>1 440 €</b>
RIGID - 00753609P	500 L	1 980 x 700	E	<b>2 335 €</b>

## ACCESORIOS VALINOX



### Kits Eléctricos

DESCRIPCIÓN	REFERENCIA	PRECIO
Kit eléctrico 1¼" - Potencia 1 500 W	3151023	<b>130 €</b>
Kit eléctrico 1¼" - Potencia 2 000 W	3151024	<b>140 €</b>



### Juego Patas / Soportes Ajustables

DESCRIPCIÓN	REFERENCIA	PRECIO
Juego patas ajustable - (2) suministrado de serie	3169010027	<b>29 €</b>
Juego soportes murales - (1) suministrado de serie	3169010028	<b>29 €</b>



### Ánodo de Magnesio

DESCRIPCIÓN	REFERENCIA	PRECIO
Ánodo de magnesio ¾"	3151049	<b>52 €</b>
Ánodo de magnesio 1¼"	3151040	<b>140 €</b>

## 03. Depósitos ACS Cobaltherm / Coballes



### Bomba de Calos ACS Deva Pro



MODELO / REFERENCIA	VOLUMEN	DIMENSIONES	CLASE ENERGÉTICA	PRECIO
59810180140	140 L	1 366 x 530	A++	<b>2 200 €</b>
59800180200	200 L	1 704 x 580	A++	<b>2 881 €</b>
59700180270	270 L	2 004 x 580	A+	<b>2 971 €</b>
59700180300	300 L	1 864 x 650	A+	<b>3 300 €</b>

### Deva Pro S

MODELO / REFERENCIA	VOLUMEN	DIMENSIONES	CLASE ENERGÉTICA	PRECIO
72700180270	270 L	2 004 x 580	A+	<b>3 230 €</b>
72700180300	300 L	1 864 x 650	A+	<b>3 553 €</b>



### Interacumulador Bomba de Calor (ACS + Inercia) Suria A



MODELO / REFERENCIA	VOLUMEN	DIMENSIONES	CLASE ENERGÉTICA	PRECIO
52700210210	1165/45 L	1 640 x 560	A+	<b>1 870 €</b>
52100210250	200/50 L	1 670 x 600	A	<b>2 400 €</b>
52100210290	200/90 L	1 865 x 600	A	<b>2 450 €</b>
52100210350	300/50 L	1 955 x 660	A	<b>3 090 €</b>
52100210380	300/80 L	1 950 x 660	A	<b>3 390 €</b>

### Interacumulador Serpentin Basic A



MODELO / REFERENCIA	VOLUMEN	DIMENSIONES	CLASE ENERGÉTICA	PRECIO
48110200100	100 L	950 x 530	A	<b>819 €</b>
48110200150	150 L	1 300 x 530	A	<b>951 €</b>
48100200200	200 L	1 700 x 530	A	<b>1 168 €</b>
48100200300	300 L	1 840 x 600	A	<b>1 344 €</b>
48101200500	500 L	1 885 x 780	A	<b>2 246 €</b>



+ Kit eléctrico monofásico opcional

**156 €**

Ref.: 800313, 3 000 W, titanio 1½"



### Interacumulador Serpentin para Bomba de Calor Kendra A



MODELO / REFERENCIA	VOLUMEN	DIMENSIONES	CLASE ENERGÉTICA	PRECIO
53100200200	200 L	1 700 x 530	A	<b>1 470 €</b>
53100200270	270 L	1 630 x 600	A	<b>1 630 €</b>
53100200300	300 L	1 850 x 600	A	<b>1 774 €</b>
53101200500	500 L	1 920 x 780	A	<b>2 900 €</b>



+ Kit eléctrico monofásico opcional

**156 €**

Ref.: 800313, 3 000 W, titanio 1/4"



### Interacumulador Bomba de Calor 2S20 A

MODELO / REFERENCIA	VOLUMEN	DIMENSIONES	CLASE ENERGÉTICA	PRECIO
21110100150	150 L	1 315 x 530	A	<b>1 380 €</b>
21111100200	200 L	1 300 x 600	A	<b>1 600 €</b>
21101100250	300 L	1 600 x 600	A	<b>2 219 €</b>



+ Kit eléctrico monofásico/trifásico opcional

**190 €**

Ref.: 9006178, 2500 W, titanio 1/4"

### 2S20

MODELO / REFERENCIA	VOLUMEN	DIMENSIONES	CLASE ENERGÉTICA	PRECIO
21101200500	500 L	1 880 x 780	B	<b>3 650 €</b>



### Interacumulador Serpentin para Bomba de Calor BC40N

MODELO / REFERENCIA	VOLUMEN	DIMENSIONES	CLASE ENERGÉTICA	PRECIO
24111100200	200 L	1 325 x 600	A	<b>1 750 €</b>
24101100250	250 L	1 580 x 600	A	<b>1 900 €</b>
24101100300	300 L	1 830 x 600	A	<b>2 243 €</b>
*24101200500	500 L	1 870 x 780	A	<b>4 000 €</b>



+ Kit eléctrico monofásico/trifásico opcional

**190 €**

Ref.: 9006178, 2500 W, titanio 1/4"



### Interacumulador Doble Pared A20 A

MODELO / REFERENCIA	VOLUMEN	DIMENSIONES	CLASE ENERGÉTICA	PRECIO
27110100100	100 L	1 253 x 420	A	<b>1 209 €</b>
27110100150	150 L	1 290 x 530	A	<b>1 400 €</b>
27110100200	200 L	1 320 x 600	A	<b>1 775 €</b>
27110100300	300 L	1 840 x 300	A	<b>2 500 €</b>



### Interacumulador Serpentin S20 A

MODELO / REFERENCIA	VOLUMEN	DIMENSIONES	CLASE ENERGÉTICA	PRECIO
20110100100	100 L	1 260 x 420	A	<b>967 €</b>
20110100150	150 L	1 315 x 530	A	<b>1 122 €</b>
20111100200	200 L	1 300 x 600	A	<b>1 415 €</b>
20101100250	250 L	1 600 x 600	A	<b>1 530 €</b>
20101100300	300 L	1 850 x 600	A	<b>1 975 €</b>



+ Kit eléctrico monofásico/trifásico opcional

**190 €**

Ref.: 9006178, 2500 W, titanio 1½"

### S20

MODELO / REFERENCIA	VOLUMEN	DIMENSIONES	CLASE ENERGÉTICA	PRECIO
20101200500	500 L	1 890 x 780	A	<b>3 140 €</b>

## ACCESORIOS COBALLES

### Kits Eléctricos



DESCRIPCIÓN	REFERENCIA	PRECIO
Kit eléctrico monofásico - Potencia 2 400 W	9006058	<b>260 €</b>
Kit eléctrico monofásico - Potencia 3 600 W	9006098	<b>609 €</b>
Kit eléctrico trifásico - Potencia 3 600 W	9006068	<b>751 €</b>
Resistencia eléctrica opcional trifásica 6 000 W 1½ titanio	800429	<b>400 €</b>
Resistencia eléctrica opcional trifásica 10 000 W 1½ titanio	800430	<b>505 €</b>



## Interacumulador Serpentin para Aerotermia AEDS-D

MODELO / REFERENCIA	VOLUMEN	DIMENSIONES	CLASE ENERGÉTICA	PRECIO
AEDS-D-0150	150 L	1 605 x 470	B	<b>1 178 €</b>
AEDS-D-0200	200 L	1 490 x 540	B	<b>1 493 €</b>
AEDS-D-0300	300 L	1 850 x 570	B	<b>1 837 €</b>
AEDS-D-0500	500 L	1 960 x 700	B	<b>3 105 €</b>

## Interacumulador Serpentin para Caldera DS1SE-D

MODELO / REFERENCIA	VOLUMEN	DIMENSIONES	CLASE ENERGÉTICA	PRECIO
DS1SE-D-100	100 L	1 195 x 470	B	<b>851 €</b>
DS1SE-D-150	150 L	1 605 x 470	B	<b>995 €</b>
DS1SE-D-200	200 L	1 490 x 540	B	<b>1 292 €</b>
DS1SE-D-250	250 L	1 850 x 570	B	<b>1 620 €</b>
DS1SE-D-300	300 L	1 960 x 700	C	<b>2 840 €</b>
8KE3KW	+ Kit resistencia con caja de control pequeña 3 000 W			<b>220 €</b>



## Interacumulador Sanit S

MODELO / REFERENCIA	VOLUMEN	DIMENSIONES	CLASE ENERGÉTICA	PRECIO
TSAN000052	100 L	898 x 581	B	<b>831 €</b>
TSAN000053	150 L	1 227 x 581	B	<b>975 €</b>
TSAN000054	200 L	1 563 x 581	B	<b>1 254 €</b>



## Interacumulador Sanit DCE

MODELO / REFERENCIA	VOLUMEN	DIMENSIONES	CLASE ENERGÉTICA	PRECIO
TSAN000066	100 L	755 x 581	B	<b>933 €</b>
TSAN000067	150 L	1 035 x 581	B	<b>1 065 €</b>
TSAN000068	200 L	1 335 x 581	B	<b>1 408 €</b>



## Interacumulador BT Duo

MODELO / REFERENCIA	VOLUMEN	DIMENSIONES	CLASE ENERGÉTICA	PRECIO
TDBT000006	250 L	1 670 x 581	C	<b>1 611 €</b>
TDBT000010	500 L	1 801 x 758	-	<b>1 881 €</b>
TDBT000011	750 L	1 977 x 858	-	<b>2 102 €</b>



## Depósito de Inercia INR-Rigid INOX



MODELO / REFERENCIA	VOLUMEN	DIMENSIONES	CLASE ENERGÉTICA	PRECIO
00523600INR	50 L	650 x 500	A	<b>600 €</b>
00523601INR	80 L	800 x 500	A	<b>610 €</b>
00523602INR	100 L	1050 x 500	A	<b>620 €</b>
00523603INR	150 L	1030 x 600	B	<b>750 €</b>
00523604INR	200 L	1330 x 600	B	<b>900 €</b>
00523606INR	300 L	1830 x 600	B	<b>1200 €</b>
00523608INR	500 L	1950 x 720	C	<b>1950 €</b>

## Depósito de Inercia INR-Rigid Acero Carbono

MODELO / REFERENCIA	VOLUMEN	DIMENSIONES	CLASE ENERGÉTICA	PRECIO
00563601INR	80 L	800 x 500	A	<b>590 €</b>
00563602INR	100 L	1050 x 500	A	<b>600 €</b>
00563603INR	150 L	1030 x 600	B	<b>670 €</b>
00563604INR	200 L	1330 x 600	B	<b>730 €</b>
00563606INR	300 L	1830 x 600	B	<b>800 €</b>
00563608INR	500 L	1950 x 720	C	<b>1150 €</b>

## Depósito de Inercia ANR-Rigid INOX



MODELO / REFERENCIA	VOLUMEN	DIMENSIONES	CLASE ENERGÉTICA	PRECIO
00523603ANR	30 L	820 x 300	A	<b>400 €</b>
00523607ANR	50 L	1200 x 300	B	<b>450 €</b>

## Depósito de Inercia ANR-Rigid Acero Carbono

MODELO / REFERENCIA	VOLUMEN	DIMENSIONES	CLASE ENERGÉTICA	PRECIO
00563602ANR	30 L	820 x 300	A	<b>280 €</b>
00563607ANR	50 L	1200 x 300	B	<b>325 €</b>



## Depósito de Inercia PF-Cloth

MODELO / REFERENCIA	VOLUMEN	DIMENSIONES	CLASE ENERGÉTICA	PRECIO
00563604PF	200 L	1 330 x 600	B	<b>730 €</b>
00562109PF	600 L	2 000 x 800	-	<b>1 300 €</b>
00562110PF	800 L	1 800 x 930	-	<b>1 400 €</b>
00562111PF	1 000 L	2 050 x 930	-	<b>1 450 €</b>
00562113PF	1 500 L	2 100 x 1 300	-	<b>1 750 €</b>
00562114PF	2 000 L	2 150 x 1 400	-	<b>2 300 €</b>

## Depósito de Inercia PF-Rigid

MODELO / REFERENCIA	VOLUMEN	DIMENSIONES	CLASE ENERGÉTICA	PRECIO
00563608PF	500 L	1950 x 720	C	<b>1 150 €</b>

## Depósito de Inercia C40 DP



MODELO / REFERENCIA	VOLUMEN	DIMENSIONES	CLASE ENERGÉTICA	PRECIO
37110010050 - 1C	50 L	680 x 420	A	<b>580 €</b>
37110210100 - 1C	100 L	1 240 x 420	A	<b>675 €</b>
37110210150 - 1C	150 L	1 300 x 530	A	<b>880 €</b>
37110020050 - 2C	50 L	680 x 420	A	<b>616 €</b>
37110220100 - 2C	100 L	1 240 x 420	A	<b>745 €</b>
37110220150 - 2C	150 L	1 300 x 530	A	<b>910 €</b>

## C40

MODELO / REFERENCIA	VOLUMEN	DIMENSIONES	CLASE ENERGÉTICA	PRECIO
37100220200 - 2C	200 L	1 330 x 600	A	<b>1 079 €</b>
37100230300 - 3C	300 L	1 800 x 600	A	<b>1 233 €</b>
37100230500 - 3C	500 L	1 880 x 780	A	<b>2 157 €</b>



## Depósito de Inercia ISCI

MODELO / REFERENCIA	VOLUMEN	DIMENSIONES	CLASE ENERGÉTICA	PRECIO
ISCI-0060-OSE	60 L	730 x 470	-	<b>600 €</b>
ISCI-0100-OSE	100 L	1 130 x 470	-	<b>650 €</b>

# 07. Calentadores Gas

## Next Evo X SFT (Estanco)

 **ARISTON**



MODELO / REFERENCIA	GAS	DIMENSIONES	CLASE ENERGÉTICA	PRECIO
11 SFT EU - 3632435	Nat	570 x 345 x 165	A	<b>554,04 €</b>
11 SFT EU - 3632436	But / Pro	570 x 345 x 165	A	<b>554,04 €</b>
16 SFT EU - 3632437	Nat	570 x 345 x 187	A	<b>685,14 €</b>
16 SFT EU - 3632438	But / Pro	570 x 345 x 187	A	<b>685,14 €</b>
3319048	+ KIT SALIDA HORIZONTAL - Medidas: 60/100 mm			<b>41 €</b>

## Fast R X (Atmosférico Bajo NOX)

 **ARISTON**



MODELO / REFERENCIA	GAS	DIMENSIONES	CLASE ENERGÉTICA	PRECIO
11 NAT EU - 3632412	Nat	617 x 310 x 211	A	<b>411,54 €</b>
11 GLP EU - 3632413	GLP	617 x 310 x 211	A	<b>361,00 €</b>

## Therm 6600 S (Estanco)

 **BOSCH**



MODELO / REFERENCIA	GAS	DIMENSIONES	CLASE ENERGÉTICA	PRECIO
T6600 12 D23 - 7731200810	Nat	570 x 340 x 190	A+	<b>740 €</b>
T6600 12 D31 - 7731200811	But	570 x 340 x 190	A+	<b>740 €</b>
T6600 14 D23 - 7731200812	Nat	570 x 340 x 190	A	<b>815 €</b>
T6600 14 D31 - 7731200813	But	570 x 340 x 190	A	<b>815 €</b>
T6600 15 D23 - 7731200814	Nat	570 x 340 x 190	A	<b>875 €</b>
T6600 15 D31 - 7731200815	But	570 x 340 x 190	A	<b>875 €</b>

## Therm 3600 S (Estanco)

 **BOSCH**



MODELO / REFERENCIA	GAS	DIMENSIONES	CLASE ENERGÉTICA	PRECIO
T3600 S 11 23 - 7731200869	Nat	575 x 335 x 180	A	<b>645 €</b>
T3600 S 11 31 - 7731200870	But	575 x 335 x 180	A	<b>645 €</b>

## Therm 4204 (Atmosférico)

 **BOSCH**

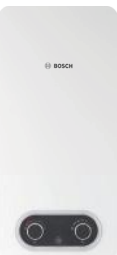

MODELO / REFERENCIA	GAS	DIMENSIONES	CLASE ENERGÉTICA	PRECIO
T4204 5 23 - 7736507624	But	531 x 270 x 225	A	<b>460 €</b>
T4204 5 31 - 7736507625	Nat	531 x 270 x 225	A	<b>460 €</b>
T4204 11 23 - 7736507626	But	655 x 310 x 225	A	<b>585 €</b>
T4204 11 31 - 7736507627	Nat	655 x 310 x 225	A	<b>560 €</b>



# Regulación y Control

# 04

## GENEBRE

Manometría Glicerina  
Rosca BSP

REFERENCIA	Ø	BAR	TIPO	PRECIO
3822 006	63	0 - 6	INF.	14,34 €
3822 010	63	0 - 10	INF.	14,34 €
3822 016	63	0 - 16	INF.	14,34 €
3822 025	63	0 - 25	INF.	14,34 €
3824 006	100	0 - 6	INF.	51,54 €
3824 010	100	0 - 10	INF.	51,54 €
3824 016	100	0 - 16	INF.	51,54 €
3829 006	63	0 - 6	POST.	15,08 €
3829 010	63	0 - 10	POST.	15,08 €
3829 016	63	0 - 16	POST.	15,08 €
3829 025	63	0 - 25	POST.	15,08 €

## GENEBRE

Manometría Esfera Seca  
Rosca BSP

REFERENCIA	Ø	BAR	TIPO	PRECIO
3820 004	53	0 - 4	INF.	5,84 €
3820 006	53	0 - 6	INF.	5,84 €
3820 010	53	0 - 10	INF.	5,84 €
3820 016	53	0 - 16	INF.	5,84 €
3820 025	53	0 - 25	INF.	5,84 €
3821 004	53	0 - 4	POST.	6,24 €
3821 006	53	0 - 6	POST.	6,24 €
3821 010	53	0 - 10	POST.	6,24 €
3821 016	53	0 - 16	POST.	6,24 €
3821 025	53	0 - 25	POST.	6,24 €

Termómetro Abrazadera  
Altas Temperaturas

REFERENCIA	Ø	RANGO	TIPO	PRECIO
6243202000	63	0... +120	POST.	11,15 €

Termómetro Bimetálico  
para Calefacción  
y Refrigeración

REFERENCIA	Ø	RANGO	TIPO	PRECIO
6203221100	63 x 50	0... +60	POST.	10,05 €
6203222100	63 x 50	0... +120	POST.	10,05 €
6203220100	63 x 50	-30... +50	POST.	10,05 €
6203220200	63 x 50	-30... +50	POST.	12,03 €
6203221200	63 x 100	0... +60	POST.	12,03 €
6203222200	63 x 100	0... +120	POST.	12,03 €
6204221100	80 x 50	0... +60	POST.	13,44 €
6204222100	80 x 50	0... +120	POST.	13,44 €
6204221200	80 x 100	0... +60	POST.	15,11 €
6204222200	80 x 100	0... +120	POST.	15,11 €
6214121100	80 x 50	0... +60	INF.	29,12 €
6214122100	80 x 50	0... +120	INF.	29,12 €
6214121200	80 x 100	0... +60	INF.	31,88 €
6214122200	80 x 100	0... +120	INF.	31,88 €

Manotermómetro  
Altas Temperaturas

REFERENCIA	Ø	BAR	RANGO	TIPO	PRECIO
7104221400	80	0 - 6	0... +120	POST.	37,02 €
7104121400	80	0 - 6	0... +120	INF.	23,14 €

Vaina Termómetro Bimetálico  
Modelo 260

REFERENCIA	MEDIDAS	BAR	PRECIO
6200020100	½" x 50 Latón	25	5,14 €
6200020200	½" x 100 Latón	25	7,63 €
6200020300	½" x 50 INOX	25	38,87 €
6200020400	½" x 100 INOX	25	38,87 €

**Vaina Latón Termómetro  
Diámetro 9/12 mm**



REFERENCIA	MEDIDA	PRECIO
361050	½" x 50 mm	<b>4,96 €</b>
361100	½" x 100 mm	<b>9,10 €</b>
361150	½" x 150 mm	<b>9,40 €</b>
361200	½" x 200 mm	<b>9,90 €</b>

**Vaina INOX Termómetros  
Bimetálicos**



REFERENCIA	MEDIDA	PRECIO
651305	50 mm	<b>23,26 €</b>
651310	100 mm	<b>36,10 €</b>
503315	150 mm	<b>30,70 €</b>
503320	200 mm	<b>31,58 €</b>

**HECAPO**

**Termómetro Capilla  
Capilla Vertical y Angular**



REFERENCIA	Ø	RANGO	TIPO	PRECIO
6250121100	50	0... +60	VER.	<b>27,38 €</b>
6250122100	50	0... +120	VER.	<b>27,38 €</b>
6250121200	100	0... +60	VER.	<b>29,10 €</b>
6250122200	100	0... +120	VER.	<b>29,10 €</b>
6260220100	50	-30... +50	ANG.	<b>32,18 €</b>
6260222100	50	0... +120	ANG.	<b>32,18 €</b>
6260221200	100	0... +60	ANG.	<b>33,96 €</b>
6260222200	100	0... +120	ANG.	<b>33,96 €</b>

**Vaina INOX Termómetros  
de Inmersión**



REFERENCIA	MEDIDA	PRECIO
VAI555	50 mm	<b>21,10 €</b>
VAI565	100 mm	<b>21,70 €</b>
VAI585	240 mm	<b>25,10 €</b>

**Boquilla Pulverizadora  
Delawan Tipo W**



REFERENCIA	MEDIDA	PRECIO
228007	60° - 0,85	<b>15,90 €</b>

**Boquilla Quemador Danfoss Tipo S. Precio: 21,89 €**



GpH TIPO S	REFERENCIA 45°	REFERENCIA 60°	REFERENCIA 80°	GpH TIPO S	REFERENCIA 45°	REFERENCIA 60°
0,40	-	229000	229090	1,75	229062	229012
0,50	-	229001	229091	2,00	229063	229013
0,55	-	229002	229092	2,25	229064	-
0,60	229053	229003	229093	2,50	229065	209015
0,65	229054	229004	229094	2,75	229066	-
0,75	229055	229005	-	3,00	229067	209017
0,85	-	229006	-	3,50	229068	209018
1,00	229057	229007	-	4,00	229069	209019
1,25	229059	229009	-	4,50	2290691	209036
1,50	229061	229011	-	5,00	229070	-

**Termómetro Esfera  
con Bulbo T-78**

REFERENCIA	MEDIDA	PRECIO
120T78	0 - 128° (1 m)	<b>15,60 €</b>
123T78	0 - 128° (3 m)	<b>14,86 €</b>
0T7800	50 - 350° (1 m)	<b>16,90 €</b>

**Termómetro Rectangular T-71**

REFERENCIA	MEDIDA	PRECIO
022001	10 - 105° (1 000 mm)	<b>10,68 €</b>

**Termohidrómetro  
con Válvula de Retención**

REFERENCIA	MEDIDA	PRECIO
4TID83	10 - 120°C	<b>27,40 €</b>

**Válvula Seguridad Antihielo D05**

REFERENCIA	MEDIDA	PRECIO
051002	DN25 1" M - 55 m³/h	<b>120,10 €</b>
051142	DN32 1¼" M - 70 m³/h	<b>120,10 €</b>

**Válvula Seguridad  
Termostática**

REFERENCIA	MEDIDA	PRECIO
140128	½" - 7 bar	<b>6,55 €</b>
140129	½" - 10 bar	<b>6,55 €</b>
172348	¾" - 7 bar	<b>14,41 €</b>
172349	¾" - 10 bar	<b>14,41 €</b>

**Válvula Presión Diferencial**

REFERENCIA	MEDIDA	PRECIO
1300-0-07	¾" H-H	<b>26,20 €</b>

**Duco Prescomano  
con Manómetro**

REFERENCIA	MEDIDA	PRECIO
101540N	½" - ¼"	<b>18,30 €</b>

**WATTS®****Válvula Seguridad MSM/E30**

REFERENCIA	MEDIDA	PRECIO
0210030	½" H-H 3 bar (toma)	<b>12,00 €</b>
0210130	½" H-H 3 bar (manómetro)	<b>23,30 €</b>
0210430	½" H-H 3 bar (manómetro)	<b>23,30 €</b>
0210730	¾" H-H 3 bar (manómetro)	<b>32,40 €</b>

**WATTS®****Válvula Seguridad MSL  
Cuerpo en Latón CW617N**

REFERENCIA	MEDIDA	PRECIO
0206530	½" M-H 3 bar	<b>13,50 €</b>
0207530	½" H-H 3 bar	<b>13,50 €</b>
0207540	½" H-H 4 bar	<b>13,50 €</b>
0207050N	½" H-H 5 bar	<b>13,50 €</b>
0206060N	½" M-H 6 bar	<b>13,50 €</b>
0207060N	½" H-H 6 bar	<b>13,50 €</b>
0206070N	½" M-H 7 bar	<b>13,50 €</b>
0207070N	½" H-H 7 bar	<b>13,50 €</b>
0207080N	½" H-H 8 bar	<b>13,50 €</b>
0207090N	½" H-H 9 bar	<b>13,50 €</b>
0207099N	½" H-H 10 bar	<b>13,50 €</b>

**WATTS****Válvula Seguridad SV (H-H)  
Cuerpo en Latón CW617N**

REFERENCIA	MEDIDA	PRECIO
0215130	½" x ¾" - 3 bar	13,60 €
0215104	½" x ¾" - 4 bar	13,60 €
0216050N	½" x ¾" - 5 bar	13,60 €
0216060N	½" x ¾" - 6 bar	13,60 €
0216070N	½" x ¾" - 7 bar	13,60 €
0216080N	½" x ¾" - 8 bar	13,60 €
0216090N	½" x ¾" - 9 bar	13,60 €
0216099N	½" x ¾" - 10 bar	13,60 €
0217630	¾" x 1" - 3 bar	27,20 €
0217604	¾" x 1" - 4 bar	27,20 €
0217050N	¾" x 1" - 5 bar	27,20 €
0217060N	¾" x 1" - 6 bar	27,20 €
0217070N	¾" x 1" - 7 bar	27,20 €
0217080N	¾" x 1" - 8 bar	27,20 €
0217090N	¾" x 1" - 9 bar	27,20 €
0217099N	¾" x 1" - 10 bar	27,20 €
0218630	1" x 1¼" - 3 bar	54,60 €
0218604	1" x 1¼" - 4 bar	54,60 €
0218305	1" x 1¼" - 5 bar	54,60 €
0218606	1" x 1¼" - 6 bar	54,60 €
0218607	1" x 1¼" - 7 bar	54,60 €
0218608	1" x 1¼" - 8 bar	54,60 €
0218699	1" x 1¼" - 8 bar	54,60 €
0219630	1¼" x 1½" - 3 bar	73,10 €
0219604	1¼" x 1½" - 4 bar	73,10 €
0219606	1¼" x 1½" - 6 bar	73,10 €
0219607	1¼" x 1½" - 7 bar	73,10 €

**orkli****Grupo Seguridad Recto**

REFERENCIA	MEDIDA	PRECIO
GS1110000	¾" - 7 bar	33,37 €

**WATTS****Grupo de Seguridad ACS SFR**

REFERENCIA	MEDIDA	PRECIO
1252550SP	¾" M-H	42,10 €
1252570SP	¾" M-H Inox	45,90 €
1252571SP	¾" M-H Acodado-Inox	47,60 €
1254555	1" M-H	121,70 €

**Potermic**  
COMPONENTES HIDROTÉRMICOS**Conector Machón Cónico**

REFERENCIA	MEDIDA	PRECIO
13-093-00	½" x ¾" M-M	6,94 €
13-080-01	¼" x ¼" M-M	6,94 €
13-082-00	¼" x ¾" M-M	5,82 €
13-083-00	¾" x ¾" M-M	5,82 €

**Potermic**  
COMPONENTES HIDROTÉRMICOS**Ánodo Magnesio  
Tapón Roscado**

REFERENCIA	MEDIDA	PRECIO
213500	¾" - 21,3 x 320	16,56 €
082106	1¼" - 32 x 320	33,56 €
082108	1¼" - 32 x 700	62,68 €
255000	1" - 25,2 x 320	24,56 €

**Potermic**  
COMPONENTES HIDROTÉRMICOS**Ánodo Magnesio  
con Varilla Roscada 25,5 x 400**

REFERENCIA	MEDIDA	PRECIO
354604	M6 x 10	22,64 €
354140	M8 x 30	22,84 €

### Resistencia Eléctrica INOX



REFERENCIA	MEDIDA	PRECIO
1500RX	1 500 W - 300 mm - 1/4"	<b>31,04 €</b>

### Resistencia Eléctrica Tipo Candela INOX



REFERENCIA	MEDIDA	PRECIO
1200RC	1 200 W	<b>13,70 €</b>



### Resistencia Eléctrica con Termostato IP65



REFERENCIA	MEDIDA	PRECIO
OW-R2	2 000 W - 230 V - 1/4"	<b>95,13 €</b>



### Resistencia Eléctrica con Termostato IP65



REFERENCIA	MEDIDA	PRECIO
OW-R3	3 000 W - 230 V - 1/4"	<b>113,40 €</b>

### Termostato Resistencia



REFERENCIA	MEDIDA	PRECIO
30TR84	20 - 80°C - 270 mm	<b>11,90 €</b>

### Termostato con Bulbo y Capilar TR/711



REFERENCIA	MEDIDA	PRECIO
711035	-35 + 35°C - 1 000 mm	<b>13,60 €</b>
711090	30 + 90°C - 1 000 mm	<b>15,50 €</b>
711093	30 + 90°C - 3 000 mm	<b>20,40 €</b>
711120	30 + 120°C - 1 000 mm	<b>15,80 €</b>
711300	50 + 300°C - 1 000 mm	<b>21,40 €</b>

### Termostato con Bulbo y Capilar TR2 (1 500 y 3 000 mm)



REFERENCIA	MEDIDA	PRECIO
540359	0 + 90°C	<b>16,66 €</b>
549227	0 + 120°C	<b>19,30 €</b>

### Termostato Limitador Seguridad (1 000 mm)



REFERENCIA	MEDIDA	PRECIO
3STB83	100°C	<b>13,40 €</b>

### Termostato Blindado con Bulbo (1500 mm)



REFERENCIA	MEDIDA	PRECIO
3F2000	30 + 90°C	<b>25,70 €</b>

**Termostato Contacto  
B-2000**



REFERENCIA	MEDIDA	PRECIO
3B2000	30 + 90°C	<b>18,60 €</b>

**Bitermostato TLSC  
(100 mm)**



REFERENCIA	MEDIDA	PRECIO
700190	0 + 90°C	<b>43,60 €</b>

**Termostato Inmersión  
Diámetro 9/12 mm**



REFERENCIA	MEDIDA	PRECIO
3C2000	30 + 90°C - 50 mm	<b>28,30 €</b>
3C2001	30 + 90°C - 100 mm	<b>28,30 €</b>
3C2002	30 + 90°C - 240 mm	<b>28,30 €</b>

**Controltherm Centralita  
Electromecánica Biomasa  
con Interruptor**



REFERENCIA	MEDIDA	PRECIO
210005	230 V - 50 Hz	<b>87,50 €</b>

**Pirostato Control  
Salida de Humos**



REFERENCIA	MEDIDA	PRECIO
054112	Vaina 1 m	<b>129,20 €</b>
054113	Vaina 3 m	<b>150,40 €</b>

**CALEFFI**

**Válvula Descarga  
Térmica**



REFERENCIA	MEDIDA	PRECIO
543513	¾" - 90°C CR	<b>182,00 €</b>

**Antifrost Solar Extra  
Propilenglicol**



REFERENCIA	MEDIDA	PRECIO
502205	5 L	<b>44,20 €</b>
502210	10 L	<b>87,20 €</b>
502220	20 L	<b>171,98 €</b>

**CALEFFI**

**Válvula Seguridad  
Presión/Temperatura**



REFERENCIA	MEDIDA	PRECIO
309530	3 bar 90°C ¾" - 22 mm	<b>108,00 €</b>

### Honeywell

#### Válvula Descarga Térmica



REFERENCIA	MEDIDA	PRECIO
TS131-3/4A	¾"	<b>122,10 €</b>

### Válvula Llenado Automático



REFERENCIA	MEDIDA	PRECIO
052515	½" M-H	<b>53,60 €</b>

### Honeywell

#### Válvula Llenado Automático



REFERENCIA	MEDIDA	PRECIO
VF06-1/2B	½"	<b>76,70 €</b>

### Boca de Carga Gas-Oil Tipo Campsa



REFERENCIA	MEDIDA	PRECIO
15-029-00	2" H	<b>89,10 €</b>

### Indicador Neumático de Nivel Gas-Oil



REFERENCIA	MEDIDA	PRECIO
15-078-05	0,9 - 3 m	<b>142,20 €</b>

### Boca de Carga 3"



REFERENCIA	MEDIDA	PRECIO
021110	3" Gas-Oil	<b>102,90 €</b>

### Sonda Indicador Neumático



REFERENCIA	MEDIDA	PRECIO
000104	16 m	<b>7,82 €</b>
000105	50 m	<b>23,44 €</b>

### Válvula Retención Vaso Expansión



REFERENCIA	MEDIDA	PRECIO
1470-0-07	¾" M-H	<b>16,84 €</b>

### Regulador de Tiro RT-4



REFERENCIA	MEDIDA	PRECIO
008037	¾" M-H	<b>50,94 €</b>

### Válvula de Pie en Plástico



REFERENCIA	MEDIDA	PRECIO
031012	¾" H Gas-Oil	<b>23,10 €</b>

### Cortafuegos Metálico Tipo Seta



REFERENCIA	MEDIDA	PRECIO
15-043-01	1¼"	<b>11,10 €</b>
15-045-01	1½"	<b>11,86 €</b>
15-046-01	2"	<b>14,64 €</b>

### Cortafuegos Tipo T



REFERENCIA	MEDIDA	PRECIO
216040	1½"	<b>29,94 €</b>

### Válvula de Pie Gas-Oil



REFERENCIA	MEDIDA	PRECIO
020812	½" - H	<b>17,24 €</b>
020838	¾" - H	<b>14,86 €</b>

### Filtro Vaso Opaco Gas-Oil



REFERENCIA	MEDIDA	PRECIO
20151E	¾"	<b>8,30 €</b>

### Válvula Retención Gas-Oil



REFERENCIA	MEDIDA	PRECIO
602015	½" - H	<b>14,66 €</b>
602012	¾" - H	<b>14,98 €</b>
602020	¾" - H	<b>18,20 €</b>

### Filtro Vaso Gas-Oil Aluminio



REFERENCIA	MEDIDA	PRECIO
20151A	¾"	<b>11,62 €</b>

### Embudo de Descarga



REFERENCIA	MEDIDA	PRECIO
A80150	½" H-H	<b>12,50 €</b>
A81200	¾" H-H	<b>13,50 €</b>
A82025	1" H-H	<b>33,90 €</b>

### Filtro Vaso Opaco Gas-Oil Cuerpo Grande



REFERENCIA	MEDIDA	PRECIO
20202P	½"	<b>27,28 €</b>

### Filtro Vaso Gas-Oil Aluminio Cuerpo Grande



REFERENCIA	MEDIDA	PRECIO
20202A	½"	<b>28,40 €</b>

### Tiger Loop Original Purgador de Aire Gas-Oil



REFERENCIA	MEDIDA	PRECIO
050500	+0,5/0,6	<b>104,98 €</b>

### Tiger Loop Combi 3 Purgador de Aire con Filtro



REFERENCIA	MEDIDA	PRECIO
060502	+0,5/0,6	<b>198,98 €</b>

### Kit Accesorios Tiger Loop



REFERENCIA	MEDIDA	PRECIO
RTL000	¼" M x ¾" H	<b>8,90 €</b>

### Barra Montaje Tipo T



REFERENCIA	MEDIDA	PRECIO
000099	Nippels 1" - Extralarga	<b>35,40 €</b>

### Gok Filtro Recirculación



REFERENCIA	MEDIDA	PRECIO
13-861-03	¾" M-H	<b>65,08 €</b>

### Cepillo Caldera sin Mango Racores M12



REFERENCIA	MEDIDA	PRECIO
500030	30 mm	<b>11,50 €</b>
500040	40 mm	<b>11,50 €</b>
500050	50 mm	<b>11,50 €</b>
500060	60 mm	<b>11,50 €</b>
500070	70 mm	<b>11,50 €</b>

### Grifo Portamanómetro con Pletina



REFERENCIA	MEDIDA	PRECIO
036710	¼"	<b>11,34 €</b>
036712	¾"	<b>15,20 €</b>
036715	½"	<b>17,90 €</b>

### Válvula Vaciado con Tapón



REFERENCIA	MEDIDA	PRECIO
125012	¾"	<b>11,42 €</b>
125015	½"	<b>12,80 €</b>
125020	¾"	<b>18,50 €</b>

### Lira Portamanómetro



REFERENCIA	MEDIDA	PRECIO
036910	¼"	<b>11,10 €</b>
036915	½"	<b>13,10 €</b>

### Purgador Automático Solar-Vent



REFERENCIA	MEDIDA	PRECIO
591000	3/8" - M	<b>124,30 €</b>
591400	1/2" - M	<b>124,30 €</b>

### Purgador Automático Compact



REFERENCIA	MEDIDA	PRECIO
050012	3/8"	<b>11,02 €</b>
050013	1/2"	<b>10,64 €</b>

### Purgador Automático Angular



REFERENCIA	MEDIDA	PRECIO
011503	3/8"	<b>12,90 €</b>
011504	1/2"	<b>12,90 €</b>

### Purgador Solar Mini Lateral



REFERENCIA	MEDIDA	PRECIO
083252	3/8"	<b>13,40 €</b>
083255	1/2"	<b>13,40 €</b>

### Honeywell Purgador Automático



REFERENCIA	MEDIDA	PRECIO
E121-3/8A	3/8"	<b>925 €</b>
E121-1/2A	1/2"	<b>10,50 €</b>

### Válvula Retención Purgador



REFERENCIA	MEDIDA	PRECIO
900010	3/8" M - H	<b>2,06 €</b>
900011	1/2" M - H	<b>2,70 €</b>

### Manguito Antielectrólisis M-H



REFERENCIA	MEDIDA	PRECIO
317015	1/2"	<b>4,00 €</b>
317020	3/4"	<b>5,24 €</b>

### Kit Soporte Vaso Calefacción ACS 7 Bar



REFERENCIA	MEDIDA	PRECIO
053023	3/4" M x 3/4" H	<b>94,60 €</b>

### Kit Soporte Vaso Calefacción 3 Bar



REFERENCIA	MEDIDA	PRECIO
053021	3/4" M x 3/4" H	<b>93,20 €</b>

### Soporte Vasoflex 5-40 Litros



REFERENCIA	MEDIDA	PRECIO
021025	3/4"	<b>8,18 €</b>
021025INOX	3/4"	<b>19,75 €</b>

### Electroválvula Cerrada Serie 86 230 V (\*24 V)



REFERENCIA	MEDIDA	MEMBRANA	PRECIO
861410N12	½" - ø12 mm	NBR	<b>91,10 €</b>
861510E20	¾" - ø20 mm	NBR	<b>97,70 €</b>
*861511N20	¾" - ø20 mm	NBR	<b>99,60 €</b>
861610E25	1" - ø25 mm	EPDM	<b>122,50 €</b>
861710N32	1¼" - ø32 mm	NBR	<b>231,10 €</b>
861810N39	1½" - ø39 mm	NBR	<b>285,90 €</b>
861910N51	2" - ø51 mm	NBR	<b>427,98 €</b>
862010N65	2½" - ø65 mm	NBRT	<b>1 222,90 €</b>
862110N75	3" - ø75 mm	NBRT	<b>1 325,98 €</b>

### Electroválvula Abierta Serie 87 230 V



REFERENCIA	MEDIDA	MEMBRANA	PRECIO
871410N12	½" - ø12 mm	NBR	<b>93,94 €</b>
871510N20	¾" - ø20 mm	NBR	<b>99,88 €</b>
871610N25	1" - ø25 mm	NBR	<b>110,90 €</b>
871710N32	1¼" - ø32 mm	NBR	<b>248,20 €</b>
871810N39	1½" - ø39 mm	NBR	<b>297,80 €</b>
871910N51	2" - ø51 mm	NBR	<b>435,20 €</b>



### Desfangador Magnético con Filtro de Perlas



REFERENCIA	MEDIDA	PRECIO
DM25V	1" Plástico	<b>87,78 €</b>
DMME25V	1" INOX	<b>93,45 €</b>



### XS Filtro / Desfangador Magnético



REFERENCIA	MEDIDA	PRECIO
545900	3 bar 0 - 90°C	<b>142,00 €</b>



### Desfangador Magnético



REFERENCIA	MEDIDA	PRECIO
545306	1" - Vertical/Horizontal	<b>200,00 €</b>
545347	1¼" - Vertical/Horizontal	<b>249,30 €</b>

### Taco Válvula Mezcladora Termostática Máx. 50 L/min



REFERENCIA	MEDIDA	PRECIO
1351-0-20	¾" 35 - 70°C	<b>49,70 €</b>

### Válvula Mezcladora Termostática 62 C. 42-60°C



REFERENCIA	MEDIDA	PRECIO
6209C12	½" H-H	<b>80,30 €</b>
6210C34	¾" H-H	<b>80,30 €</b>
6211C1	1" H-H	<b>85,30 €</b>

### Válvula Anticondensación



REFERENCIA	MEDIDA	PRECIO
132555	1" 55°C	<b>97,90 €</b>

### Válvula Mezcladora Termomix 3 Vías



REFERENCIA	MEDIDA	PRECIO
460020	¾" - Kv 6,0	<b>83,94 €</b>
460025	1" - Kv 2,0	<b>92,80 €</b>
460032	1¼" - Kv 18,0	<b>121,70 €</b>
460040	1½" - Kv 26,0	<b>212,20 €</b>
460050	2" - Kv 40,0	<b>282,00 €</b>

### Válvula VPR 2,5 Mezcladora / Derivadora Termostatizable



REFERENCIA	MEDIDA	PRECIO
753412	1" M	<b>106,20 €</b>



### Flujostato 315



REFERENCIA	MEDIDA	PRECIO
315400	½" 230 V - 6 bar	<b>80,00 €</b>
315500	¾" 230 V - 6 bar	<b>80,00 €</b>



### Mezclador Termostático



REFERENCIA	MEDIDA	PRECIO
520440	½"	<b>87,00 €</b>
520540	¾"	<b>89,00 €</b>
520640	1"	<b>116,00 €</b>

### Servomix M03.3 On-Off a 3 Puntos



REFERENCIA	MEDIDA	PRECIO
030101	230 V 50 Hz sin micro	<b>151,10 €</b>

### Servomix M04 Modulante



REFERENCIA	MEDIDA	PRECIO
040103	24 V - 50 Hz - 5 Nm	<b>292,30 €</b>

**WATTS****Válvula Reductora  
de Presión Junior**

REFERENCIA	MEDIDA	PRECIO
149B7209	½" H - H	<b>46,60 €</b>
149B7210	¾" H - H	<b>52,40 €</b>

**Potermic**  
COMPONENTES HIDROTÉRMICOS**Válvula Reguladora TU  
Presión Diferencial DN25**

REFERENCIA	MEDIDA	PRECIO
551025	1" H-H   0,05 - 0,5 bar	<b>191,90 €</b>

**CALEFFI****Reductora Presión 5334**

REFERENCIA	MEDIDA	PRECIO
533441	½" - PN15	<b>50,00 €</b>
533451	¾" - PN15	<b>55,00 €</b>

**Potermic**  
COMPONENTES HIDROTÉRMICOS**Filtro Angular  
con Válvula de Vacío**

REFERENCIA	MEDIDA	PRECIO
154015	½"	<b>14,78 €</b>
154020	¾"	<b>18,68 €</b>
154025	1"	<b>24,48 €</b>
154032	1¼"	<b>37,88 €</b>
154040	1½"	<b>46,28 €</b>
154050	2"	<b>75,48 €</b>

**Honeywell****Filtro Miniplus 100 µm**

REFERENCIA	MEDIDA	PRECIO
FF06-1/2AA	½"	<b>84,40 €</b>
FF06-3/4AA	¾"	<b>92,30 €</b>
FF06-1AA	1"	<b>112,80 €</b>
FF06-11/4AA	1¼"	<b>125,20 €</b>
FF06-3/4AAM	¾" Cuerpo Latón	<b>190,00 €</b>

**Honeywell****Filtro Malla 100 µm**

REFERENCIA	MEDIDA	PRECIO
F76S-1AA	1"	<b>448,00 €</b>
F76S-11/4AA	1¼"	<b>500,00 €</b>
F76S-11/2AA	1½"	<b>678,00 €</b>
F76S-2AA	2"	<b>745,00 €</b>

## Válvula Reductora de Presión



REFERENCIA	MEDIDA	PRECIO
D04FM-3/4A	¾"	<b>47,80 €</b>

## Desconector Hidráulico



REFERENCIA	MEDIDA	PRECIO
CA295-1/2A	½"	<b>81,90 €</b>
CA295-3/4A	¾"	<b>85,10 €</b>

## Válvula Reductora de Presión



REFERENCIA	MEDIDA	PRECIO
D05FS-1/2A	½"	<b>91,20 €</b>
D05FS-3/4A	¾"	<b>103,30 €</b>
D05FS-1A	1"	<b>131,70 €</b>
D05FS-11/4A	1¼"	<b>205,00 €</b>
D05FS-11/2A	1½"	<b>353,00 €</b>
D05FS-2A	2"	<b>404,00 €</b>

## Desconector Hidráulico con Tomas



REFERENCIA	MEDIDA	PRECIO
BA295S-1/2A	½"	<b>378,00 €</b>
BA295S-3/4A	¾"	<b>401,00 €</b>
BA295S-1A	1"	<b>501,00 €</b>
BA295S-11/4A	1¼"	<b>682,00 €</b>
BA295S-11/2A	1½"	<b>986,00 €</b>

## Válvula Reductora de Presión con Filtro



REFERENCIA	MEDIDA	PRECIO
D06F-1/2A	½"	<b>125,00 €</b>
D06F-3/4A	¾"	<b>130,00 €</b>
D06F-1A	1"	<b>171,00 €</b>
D06F-11/4A	1¼"	<b>261,00 €</b>
D06F-11/2A	1½"	<b>456,00 €</b>
D06F-2A	2"	<b>523,00 €</b>

**Potermic**  
COMPONENTES HIDROTÉRMICOS

## Motor Synchron Recambio Válvulas de Zona



REFERENCIA	MEDIDA	PRECIO
227500	230 V 50 Hz	<b>3,40 €</b>

### Honeywell

#### Válvula de Zona 2 Vías Contacto Auxiliar



REFERENCIA	MEDIDA	PRECIO
V4043H1114/U	¾"	117,50 €
V4043H1122/U	1"	117,50 €

#### Válvula de Zona 2 Vías con Micro 5 Hilos



REFERENCIA	MEDIDA	PRECIO
30323200	1"	182,51 €

### Honeywell

#### Válvula de Zona 3 Vías



REFERENCIA	MEDIDA	PRECIO
V4044C1189/U	¾"	118,80 €
V4044C1312/U	1"	118,80 €

#### Válvula de Zona 3 Vías con Micro 5 Hilos



REFERENCIA	MEDIDA	PRECIO
40223200	¾"	181,60 €
40323200	1"	183,08 €

### Honeywell

#### Válvula de Zona 3 Vías Contacto Auxiliar



REFERENCIA	MEDIDA	PRECIO
V4044F1000/U	¾"	130,80 €
V4044F1034/U	1"	130,80 €

#### Válvula de Zona



REFERENCIA	MEDIDA	PRECIO
50014200	Sin micro 240 V	104,75 €
50024200	Con micro 240 V	113,56 €

#### Válvula de Zona 2 Vías



REFERENCIA	MEDIDA	PRECIO
39204000	¾"	40,77 €
39304000	1"	42,82 €

#### Válvula de Zona 3 Vías



REFERENCIA	MEDIDA	PRECIO
49204000	¾"	41,56 €
49304000	1"	43,73 €



### Aercal Purgador Automático



REFERENCIA	MEDIDA	PRECIO
507611	1" Derecha	<b>25,50 €</b>
507621	1" Izquierda	<b>25,50 €</b>

### Purgador Automático Tacavent



REFERENCIA	MEDIDA	PRECIO
240.5420.000	½"	<b>8,40 €</b>

### Tapón-Purgador Automático



REFERENCIA	MEDIDA	PRECIO
87A25D	1" Derecha	<b>8,60 €</b>
87A25I	1" Izquierda	<b>8,60 €</b>

### Purgador Automático Tacavent



REFERENCIA	MEDIDA	PRECIO
240.5417.000	½"	<b>3,94 €</b>

### Purgador Ranura Orientable



REFERENCIA	MEDIDA	PRECIO
204012	½"	<b>1,28 €</b>

### Purgador Automático de Boya Radiador



REFERENCIA	MEDIDA	PRECIO
85032D	1¼" Derecha	<b>14,14 €</b>
85032I	1¼" Izquierda	<b>14,14 €</b>

### Purgador Radiador con Junta Tórica



REFERENCIA	MEDIDA	PRECIO
105018	½"	<b>1,72 €</b>

**Tapón Ciego Zincado Ø42  
Radiador de Aluminio**

REFERENCIA	MEDIDA	PRECIO
55101I	1" Izquierda	<b>0,82 €</b>
55101D	1" Derecha	<b>0,82 €</b>

**Tapón Ciego Pintado Ø48  
Radiador Hierro o Acero**

REFERENCIA	MEDIDA	PRECIO
56301I	1" Izquierda	<b>2,88 €</b>
56301D	1" Derecha	<b>2,88 €</b>

**Reducción Zincada Ø42  
Radiador de Aluminio**

REFERENCIA	MEDIDA	PRECIO
55312I	1" x ½" Izquierda	<b>0,86 €</b>
55312D	1" x ½" Derecha	<b>0,86 €</b>
55318I	1" x ⅜" Izquierda	<b>0,86 €</b>
55318D	1" x ⅜" Derecha	<b>0,86 €</b>
55338I	1" x ⅜" Izquierda	<b>0,86 €</b>
55338D	1" x ⅜" Derecha	<b>0,86 €</b>

**Reducción Pintada Ø48  
Radiador de Aluminio**

REFERENCIA	MEDIDA	PRECIO
56412I	1" x ½" Izquierda	<b>2,96 €</b>
56412D	1" x ½" Derecha	<b>2,96 €</b>
56418I	1" x ⅜" Izquierda	<b>2,96 €</b>
56418D	1" x ⅜" Derecha	<b>2,96 €</b>
56438I	1" x ⅜" Izquierda	<b>1,48 €</b>
56438D	1" x ⅜" Derecha	<b>1,48 €</b>

**Tapón Ciego Pintado Ø42  
Radiador de Aluminio**

REFERENCIA	MEDIDA	PRECIO
55701I	1" Izquierda	<b>1,02 €</b>
55701D	1" Derecha	<b>1,02 €</b>

**Reducción Pintada Ø42  
Radiador de Aluminio**

REFERENCIA	MEDIDA	PRECIO
55812I	1" x ½" Izquierda	<b>1,08 €</b>
55812D	1" x ½" Derecha	<b>1,08 €</b>
55818I	1" x ⅜" Izquierda	<b>1,08 €</b>
55818D	1" x ⅜" Derecha	<b>1,08 €</b>
55838I	1" x ⅜" Izquierda	<b>1,08 €</b>
55838D	1" x ⅜" Derecha	<b>1,08 €</b>

**Reducción Zincada Ø56  
Radiador Hierro o Acero**

REFERENCIA	MEDIDA	PRECIO
55612I	1¼" x ½" Izquierda	<b>3,52 €</b>
55612D	1¼" x ½" Derecha	<b>3,52 €</b>
55618I	1¼" x ⅜" Izquierda	<b>3,52 €</b>
55618D	1¼" x ⅜" Derecha	<b>3,52 €</b>
55638I	1¼" x ⅜" Izquierda	<b>3,52 €</b>
55638D	1¼" x ⅜" Derecha	<b>3,52 €</b>

**Reducción Zincada Ø48  
Radiador Hierro o Acero**



REFERENCIA	MEDIDA	PRECIO
56612I	1" x ½" Izquierda	<b>1,26 €</b>
56612D	1" x ½" Derecha	<b>1,26 €</b>
56618I	1" x ⅜" Izquierda	<b>1,26 €</b>
56618D	1" x ⅜" Derecha	<b>1,26 €</b>
56638I	1" x ⅜" Izquierda	<b>1,26 €</b>
56638D	1" x ⅜" Derecha	<b>1,26 €</b>

**Tapón Cromado Ø27  
con Junta Tórica**



REFERENCIA	MEDIDA	PRECIO
107012	½"	<b>0,96 €</b>

**Reducción Cromada Ø27  
con Junta Tórica**



REFERENCIA	MEDIDA	PRECIO
107038	½" x ⅜"	<b>1,80 €</b>

**Tapón Ciego Zincado Ø56  
Radiador Hierro o Acero**



REFERENCIA	MEDIDA	PRECIO
55632I	1¼" Izquierda	<b>3,34 €</b>
55632D	1¼" Derecha	<b>3,34 €</b>

**Manguito Unión Radiador  
Acero Negro**



REFERENCIA	MEDIDA	PRECIO
560001	1"	<b>0,56 €</b>
560114	¼"	<b>1,20 €</b>

**Reducción Fundición Ciego  
Zinc Negro**



REFERENCIA	MEDIDA	PRECIO
56501D	ø48 M - Derecha	<b>1,22 €</b>
56501I	ø48 M - Izquierda	<b>1,22 €</b>

**Soporte Radiador  
Aluminio Curva 1"**



REFERENCIA	MEDIDA	PRECIO
1340Z3	65 mm	<b>1,34 €</b>
1341Z3	85 mm	<b>1,60 €</b>

**Soporte Radiador  
Hierro Fundido Curva 1¼"**



REFERENCIA	MEDIDA	PRECIO
1340Z2	2 columnas 50 mm	<b>1,30 €</b>
1340Z5	3 columnas 65 mm	<b>1,61 €</b>
1340Z4	4 columnas 95 mm	<b>1,72 €</b>

**Soporte Empotrar  
Galvanizado**

REFERENCIA	MEDIDA	PRECIO
139012	150 mm	<b>1,06 €</b>

**Soporte Telescópico  
Aluminio (Par)**

REFERENCIA	MEDIDA	PRECIO
135085	145 mm	<b>2,28 €</b>

**Florón Doble  
en Polipropileno**

REFERENCIA	MEDIDA	PRECIO
167016	15 mm	<b>1,17 €</b>

**Florón Simple Universal  
en Polipropileno**

REFERENCIA	MEDIDA	PRECIO
169015	10 - 25 mm	<b>0,32 €</b>

**Florón Abierto  
Latón Cromado**

REFERENCIA	MEDIDA	PRECIO
790116	15/16	<b>2,70 €</b>

**Racor con Florón  
INOX 90 mm**

REFERENCIA	MEDIDA	PRECIO
792012	12 - ½"	<b>6,60 €</b>
792016	15 - ½"	<b>5,64 €</b>

**Junta de Fibra Verde  
Radiador Fundición**

REFERENCIA	MEDIDA	PRECIO
159048	1"48 x 33 x 1	<b>0,20 €</b>
159049	1"48 x 33 x 1,8	<b>0,17 €</b>
159050	1¼"56 x 42 x 1,8	<b>0,26 €</b>
159056	1¼"56 x 42 x 1	<b>0,25 €</b>

**Junta Blanca Plana  
Radiador Aluminio**

REFERENCIA	MEDIDA	PRECIO
143044	1"42 x 33 x 1	<b>0,12 €</b>



**Separador Hidráulico  
AISI304**



REFERENCIA	MEDIDA	PRECIO
SH25	DN25 - 1" Aislado	<b>140,43 €</b>
SH32A	DN32 - 1¼" Aislado	<b>195,56 €</b>

**Separador Hidráulico  
P Max 50 kW 3 m³/h**



REFERENCIA	MEDIDA	PRECIO
210040	1½" M x 1½" H	<b>265,60 €</b>

**Grupo de Impulsión  
Directo DN25 sin Bomba**



REFERENCIA	MEDIDA	PRECIO
312500	1½" M x 1" H	<b>237,50 €</b>

**Separador Hidráulico  
Fabricado en Acero DN 25**



REFERENCIA	MEDIDA	PRECIO
220040	1½" M x 1½" M	<b>316,60 €</b>

**Grupo de Impulsión  
Punto Fijo sin Bomba**



REFERENCIA	MEDIDA	PRECIO
020250	1½" M x 1" H	<b>448,74 €</b>

**Separador Hidráulico  
Aislado P73 DN25 3 m³/h**



REFERENCIA	MEDIDA	PRECIO
730025	1½" M - 1½" M - ½" H	<b>549,58 €</b>

**Colector Distribución  
Aislado P72 DN25 3 m³/h**



REFERENCIA	MEDIDA	PRECIO
720402	1½" M - H   2 zonas	<b>365,30 €</b>
720403	1½" M - H   3 zonas	<b>460,00 €</b>

**Armario Colector Tapa  
Soporte Corredizo**



REFERENCIA	MEDIDA	PRECIO
500	320 x 300 mm	<b>18,60 €</b>
600	470 x 300 mm	<b>22,20 €</b>
700	570 x 300 mm	<b>40,20 €</b>
800	640 x 300 mm	<b>48,30 €</b>

### Colector sin Llave



REFERENCIA	MEDIDA	PRECIO
70035 05 02	¾" - 2 Vías	<b>8,86 €</b>
70035 05 03	¾" - 3 Vías	<b>12,14 €</b>
70035 05 04	¾" - 4 Vías	<b>15,14 €</b>
70035 06 02	1" - 2 Vías	<b>14,17 €</b>
70035 06 03	1" - 3 Vías	<b>18,58 €</b>
70035 06 04	1" - 4 Vías	<b>23,23 €</b>

### Colector sin Llave PN10



REFERENCIA	MEDIDA	PRECIO
70024 05 02	¾" - 2 Vías	<b>7,07 €</b>
70024 05 03	¾" - 3 Vías	<b>9,24 €</b>
70024 05 04	¾" - 4 Vías	<b>10,89 €</b>
70024 06 02	1" - 2 Vías	<b>11,60 €</b>
70024 06 03	1" - 3 Vías	<b>15,30 €</b>
70024 06 04	1" - 4 Vías	<b>18,98 €</b>

### Colector con Llave



REFERENCIA	MEDIDA	PRECIO
70171 05 02	¾" - 2 Vías	<b>28,32 €</b>
70171 05 03	¾" - 3 Vías	<b>34,73 €</b>
70171 05 04	¾" - 4 Vías	<b>45,44 €</b>
70171 06 02	1" - 2 Vías	<b>26,57 €</b>
70171 06 03	1" - 3 Vías	<b>38,47 €</b>
70171 06 04	1" - 4 Vías	<b>52,16 €</b>

### Colector de Distribución



REFERENCIA	MEDIDA	PRECIO
70176 06 04	1" - 4 Vías	<b>21,67 €</b>
70176 06 05	1" - 5 Vías	<b>26,16 €</b>
70176 06 06	1" - 6 Vías	<b>29,55 €</b>

### Tapón Ciego Colector



REFERENCIA	MEDIDA	PRECIO
70042 00 00	W24,5 x 19h/1	<b>6,16 €</b>

### Ovalillo Tubo Multicapa



REFERENCIA	MEDIDA	PRECIO
70070 16 00	16 x 2 mm	<b>2,63 €</b>
70070 20 00	20 x 2 mm	<b>3,50 €</b>
70070 20 20	20 x 2,25 mm	<b>3,02 €</b>

### Ovalillo Tubo PEX



REFERENCIA	MEDIDA	PRECIO
70071 16 00	16 x 2 mm	<b>3,48 €</b>

### Llave Ovalillos



REFERENCIA	MEDIDA	PRECIO
70069 00 00	-	<b>29,86 €</b>

## Termostato DT90 Ambiente Digital

Con pantalla de gran tamaño LCD y sencillo manejo.



REFERENCIA	MEDIDA	PRECIO
DT90A1008	-	<b>57,30 €</b>

## Termostato DT92 Radiofrecuencia

Con comunicación RF bidireccional, pantalla LCD de gran tamaño y sencillo uso.



REFERENCIA	MEDIDA	PRECIO
DT92A1004	-	<b>163,00 €</b>

## Cronotermostato T3 Semanal Cableado

Control automático de los horarios y la temperatura de la calefacción en locales domésticos o comerciales pequeños.



REFERENCIA	MEDIDA	PRECIO
T3H110A0050	-	<b>98,20 €</b>

## Cronotermostato T3R Inalámbrico Soporte

Control automático de los horarios y la temperatura de la calefacción en locales domésticos o comerciales pequeños.



REFERENCIA	MEDIDA	PRECIO
Y3H710RF0067	-	<b>169,00 €</b>

## Cronotermostato T4 Cableado Pared

Compatible con aplicaciones a 24-230 V on/off como calderas de gas, calderas combi y bombas de calor.



REFERENCIA	MEDIDA	PRECIO
T4H110A1022	-	<b>143,50 €</b>

## Cronotermostato T4R Inalámbrico Soporte

Compatible con aplicaciones 24-230 V on/off y OpenTherm como calderas de gas, calderas combi y bombas de calor.



REFERENCIA	MEDIDA	PRECIO
Y4H910RF4005	-	<b>243,00 €</b>

## Termostato Inteligente Lyric 6 con Cable Negro

Configuración guiada de termostato y aplicación Control de temperatura basado en ubicación (Geofencing).



REFERENCIA	MEDIDA	PRECIO
Y6H810WF1005	-	<b>228,00 €</b>

## Termostato Inteligente Lyric T6R Inalámbrico Negro

Configuración guiada de termostato y aplicación Control de temperatura basado en ubicación (Geofencing).



REFERENCIA	MEDIDA	PRECIO
Y6H910RW4013	-	<b>292,00 €</b>

**Termostato RT310**

Frio/calor, ambiente digital.



REFERENCIA	MEDIDA	PRECIO
S00 115 310	-	<b>49,56 €</b>

**Cronotermostato RT510**

Programación 5+2, retroiluminado.



REFERENCIA	MEDIDA	PRECIO
S00 115 510	-	<b>60,48 €</b>

**Termostato RT310RF**

Radiofrecuencia frío/calor.



REFERENCIA	MEDIDA	PRECIO
S00 115 311	-	<b>96,91 €</b>

**Cronotermostato RT510RF**

Radiofrecuencia, retroiluminado.



REFERENCIA	MEDIDA	PRECIO
S00 115 511	-	<b>106,47 €</b>

**Termostato ambiente  
ERT 20RF**

Radiofrecuencia frío/calor.



REFERENCIA	MEDIDA	PRECIO
S00 112 224	-	<b>89,70 €</b>

**Termostato Programable  
Internet iT800**

Frio/calor control a través de un smartphone.



REFERENCIA	MEDIDA	PRECIO
S00 111 800	-	<b>209,70 €</b>

**Cronotermostato  
RT520RFOP**

Radiofrecuencia frío/calor, OPENTHERM.



REFERENCIA	MEDIDA	PRECIO
S00 115 521	-	<b>140,17 €</b>

**Termostato Programable  
Internet iT700**

Frio/calor control a través de un smartphone.



REFERENCIA	MEDIDA	PRECIO
S00 111 700	-	<b>209,70 €</b>



## Rele Radiofrecuencia MS230

Radiofrecuencia, emisor y receptor.



REFERENCIA	MEDIDA	PRECIO
S00 999 868	-	93,13 €



## TYBOX HOME RF210 Kit Termostato calefacción

Compuesto por 1 Tybox RF210 y 1 Tydom Home



REFERENCIA	MEDIDA	PRECIO
6053089	-	289,00 €



## Termostato TYBOX 21 Electrónico Filar

Termostato de ambiente filar para calefacción de agua caliente.



REFERENCIA	MEDIDA	PRECIO
6053034	-	63,00 €



## Termostato TYBOX RF 210 Inalámbrico

Para CALEFACCIÓN o CLIMATIZACIÓN, mono/multizonas.



REFERENCIA	MEDIDA	PRECIO
6051149	-	155,00 €



## Cronotermostato CM1

Termostato digital frío y calor versión cable. Sin programación.



REFERENCIA	MEDIDA	PRECIO
CM1P	-	34,56 €



## Cronotermostato WM4

Cronotermostato digital frío y calor Radio Frecuencia WiFi integrado



REFERENCIA	MEDIDA	PRECIO
WM4	-	86,40 €



## Pack TYBOX 5000

Pack termostato filar conectado para calefacción de agua caliente para una zona



REFERENCIA	MEDIDA	PRECIO
6050661	-	235,00 €



## Termostato TYBOX 117+

Termostato programable filar para calefacción.



REFERENCIA	MEDIDA	PRECIO
6053072	-	119,00 €



## Termostato TYBOX 137+ Inalámbrico

Termostato programable radio para calefacción.



REFERENCIA	MEDIDA	PRECIO
6053073	-	243,00 €

### Detentor Recto Ovalillo



REFERENCIA	MEDIDA	PRECIO
87310	3/8" - M24 x 1,5	<b>14,82 €</b>
88310	1/2" - M24 x 1,5	<b>14,82 €</b>

### Detentor Conexión Hembra Escuadra



REFERENCIA	MEDIDA	PRECIO
1015	3/8" Roscar	<b>13,67 €</b>
1025	1/2" Roscar	<b>15,75 €</b>

### Detentor Conexión Hembra Recta



REFERENCIA	MEDIDA	PRECIO
1016	3/8" Roscar	<b>16,75 €</b>
1026	1/2" Roscar	<b>19,57 €</b>

### Válvula Recta Ovalillo



REFERENCIA	MEDIDA	PRECIO
82310	1/2" - M24 x 1,5	<b>19,21 €</b>

### Válvula No Termostatizable Conexión Hembra Recta



REFERENCIA	MEDIDA	PRECIO
1126	1/2" Roscar	<b>20,61 €</b>

### Válvula No Termostatizable Conexión Hembra Escuadra



REFERENCIA	MEDIDA	PRECIO
1115	3/8" Roscar	<b>14,62 €</b>
1125	1/2" Roscar	<b>16,67 €</b>

### Válvula No Termostatizable Conexión Soldar Escuadra



REFERENCIA	MEDIDA	PRECIO
1325	1/2" - ø15	<b>16,58 €</b>

### Detentor Conexión Macho Escuadra



REFERENCIA	MEDIDA	PRECIO
87210	3/8" - M24 x 1,5	<b>11,53 €</b>
1220	1/2" - M24 x 1,5	<b>11,53 €</b>

### Detentor Conexión Soldar Escuadra



REFERENCIA	MEDIDA	PRECIO
1425	1/2" - ø15	<b>13,72 €</b>

### Válvula No Termostatizable Ovalillo



REFERENCIA	MEDIDA	PRECIO
81210	3/8" - M24 x 1,5	<b>14,80 €</b>
82210	1/2" - M24 x 1,5	<b>14,80 €</b>

### Válvula Monotubo Termostática



REFERENCIA	MEDIDA	PRECIO
52490	1/2" Cierre total	<b>35,89 €</b>

### Válvula Monotubo Termostática



REFERENCIA	MEDIDA	PRECIO
52710	1/2" - M24 x 1,5	<b>35,89 €</b>

### Válvula Monotubo Termostática Pared



REFERENCIA	MEDIDA	PRECIO
52110	1/2" - M24 x 1,5 - Izq	<b>52,12 €</b>
52310	1/2" - M24 x 1,5 - Der	<b>52,12 €</b>

### Válvula Monotubo No Termostatizable Conexión Macho



REFERENCIA	MEDIDA	PRECIO
1816	1/2" - M24 x 1,5	<b>31,83 €</b>

### Válvula Termostatizable Soldar



REFERENCIA	MEDIDA	PRECIO
67401	1/2" - ø15	<b>15,80 €</b>

### Válvula Termostatizable Doble Reglaje



REFERENCIA	MEDIDA	PRECIO
67120	3/8" - Derecha	<b>16,33 €</b>

### Válvula Invertida Termostatizable Ovalillo



REFERENCIA	MEDIDA	PRECIO
67390	3/8"	<b>Consultar</b>
67690	1/2"	<b>17,01 €</b>

### Válvula Termostatizable Ovalillo Doble Reglaje



REFERENCIA	MEDIDA	PRECIO
67122	3/8" - M24 x 1,5	<b>17,96 €</b>
67422	1/2" - M24 x 1,5	<b>17,96 €</b>

### Válvula Recta Ovalillo



REFERENCIA	MEDIDA	PRECIO
67290	3/8" - M24 x 1,5	<b>20,03 €</b>
67590	1/2" - M24 x 1,5	<b>20,03 €</b>

### Válvula Termostatizable



REFERENCIA	MEDIDA	PRECIO
67150	3/8"	<b>14,98 €</b>
67450	1/2"	<b>17,58 €</b>

### Válvula Recta Termostatizable



REFERENCIA	MEDIDA	PRECIO
67250	3/8"	<b>16,95 €</b>
67550	1/2"	<b>19,41 €</b>

### Válvula Termostatizable Ovalillo



REFERENCIA	MEDIDA	PRECIO
67190	3/8" - M24 x 1,5	<b>15,89 €</b>
67490	1/2" - M24 x 1,5	<b>15,89 €</b>

### Racor Rosca Macho



REFERENCIA	MEDIDA	PRECIO
52490	½" Cierre total	<b>35,89 €</b>

### Juego Ovalillo PEX 2 Unidades



REFERENCIA	MEDIDA	PRECIO
E-13816	15 x 1,7 mm	<b>10,25 €</b>
E-15700	16 x 1,8 mm	<b>10,25 €</b>

### Cabezal Eroso Termostático Sensor Líquido



REFERENCIA	MEDIDA	PRECIO
CT211400	M28 x 1	<b>26,79 €</b>

### Manguito Telescópico



REFERENCIA	MEDIDA	PRECIO
E-20185	¾"	<b>10,44 €</b>
E-19733	½"	<b>9,33 €</b>

### Juego Ovalillo Multicapa 2 Unidades



REFERENCIA	MEDIDA	PRECIO
E-13727	16 x 2 mm	<b>11,38 €</b>

### Juego Ovalillo Cobre 2 Unidades



REFERENCIA	MEDIDA	PRECIO
E-5135	12 mm	<b>6,74 €</b>
E-5137	14 mm	<b>6,74 €</b>
E-5139	15 mm	<b>6,74 €</b>
E-5141	16 mm	<b>6,74 €</b>
E-5427	18 mm	<b>6,74 €</b>

### Juego Ovalillo Multicapa 2 Unidades



REFERENCIA	MEDIDA	PRECIO
E-13667	18 x 2 mm	<b>11,59 €</b>
E-13670	20 x 2 mm	<b>11,59 €</b>
E-13643	20 x 2,25 mm	<b>11,59 €</b>

**Detentor Ovalillo**

REFERENCIA	MEDIDA	PRECIO
38813	½" - M24 x 1,5	<b>10,22 €</b>

**Cabezal Termostático Líquido W6**

REFERENCIA	MEDIDA	PRECIO
38322	W6	<b>13,20 €</b>

**Válvula Ovalillo**

REFERENCIA	MEDIDA	PRECIO
38811	½" - M24 x 1,5	<b>13,29 €</b>

**Juego Ovalillo Multicapa**

REFERENCIA	MEDIDA	PRECIO
38834	16 mm - M24 x 1,5	<b>13,29 €</b>

**Válvula Termostatizable Ovalillo**

REFERENCIA	MEDIDA	PRECIO
38823	½" - M24 x 1,5	<b>15,21 €</b>

**Juego Ovalillo Cobre**

REFERENCIA	MEDIDA	PRECIO
38829	15 mm - M24 x 1,5	<b>3,11 €</b>

**HECAPO****Kit Soporte Vaso Expansión INOX 304 para Calefacción**

- Soporte de acero inoxidable 304
- Válvula doble retención M-H ¾"
- Válvula seguridad para caldera M-H ½" x ¾" - 3 bar
- Purgador automático de aire de ½"
- Válvula retención para purgador de ½"
- Manómetro Ø63 vertical ¼" - 0-4 bar con sector verde y aguja roja en el visor

REFERENCIA	MEDIDA	PRECIO
5394010000	H-H - ¾" - 250 mm	<b>105,00 €</b>

**HECAPO****Kit Soporte Vaso Expansión INOX 304 para ACS**

- Soporte de acero inoxidable 304
- Válvula doble retención M-H ¾"
- Válvula seguridad para caldera M-H ½" x ¾" - 3 bar
- Purgador automático de aire de ½"
- Válvula retención para purgador de ½"
- Manómetro Ø63 vertical ¼" - 0-4 bar con sector verde y aguja roja en el visor

REFERENCIA	MEDIDA	PRECIO
5394020000	H-H - ¾" - 250 mm	<b>105,00 €</b>

## 02. Vasos de Expansión



### Depósito Pressurewave (Agua Fría)

- Diseño de diafragma
- Conexión de agua de acero inoxidable patentada
- Revestimiento de polipropileno virgen
- Placa de conexión reforzada en los modelos en línea a partir de 8L
- Acabado de pintura de poliuretano de doble capa
- Válvula de aire sellada con junta tórica sin fugas
- Base del tanque / pies del tanque / soporte de la bomba reemplazables
- Pruebas exhaustivas
- Libre de mantenimiento

MODELO	REFERENCIA	PRECIO
8 L VERTICAL	PWB 8LX	<b>73,20 €</b>
12 L VERTICAL	PWB 12LX	<b>80,35 €</b>
18 L VERTICAL	PWB 18LX	<b>92,55 €</b>
24 L VERTICAL	PWB 24LX	<b>110,25 €</b>
24 L E-*WAVE	PEB 24LX	<b>88,00 €</b>
60 L VERTICAL	PWB 60LV	<b>266,70 €</b>
60 L HORIZONTAL	PWB 60LH	<b>277,85 €</b>
80 L VERTICAL	PWB 80LV	<b>314,80 €</b>
80 L HORIZONTAL	PWB 80LH	<b>347,20 €</b>
100 L VERTICAL	PWB 100LV	<b>431,00 €</b>
150 L VERTICAL	PWB 150LV	<b>611,35 €</b>

\*HIDROESFERA

### Vaso Expansión Calefacción



- Diafragma de butilo de alta calidad
- Acabado de pintura de poliuretano de doble capa
- Revestimiento de polipropileno virgen
- Conexión acero cromado
- Válvula de aire sellada con junta tórica sin fugas
- Pruebas exhaustivas

MODELO	REFERENCIA	PRECIO
12 L	HWB 12LX	<b>60,30 €</b>
18 L	HWB 18LX	<b>63,35 €</b>
24 L	HWB 24LX	<b>78,40 €</b>
35 L	HWB 35LX	<b>119,20 €</b>
60 L	HWB 60LV	<b>195,45 €</b>
80 L	HWB 80LV	<b>270,65 €</b>
100 L	HWB 100LV	<b>363,80 €</b>
150 L	HWB 150LV	<b>469,10 €</b>

### Vaso Expansión ACS



- Diafragma de butilo de alta calidad
- Revestimiento de polipropileno virgen
- Acabado de pintura de poliuretano de dos partes con imprimación
- Conexión de agua de acero inoxidable patentada
- Válvula de aire sellada con junta tórica sin fugas
- Base del tanque reemplazable
- Pruebas exhaustivas
- Libre de mantenimiento

MODELO	REFERENCIA	PRECIO
8 L	TWB 8LX	<b>73,15 €</b>
12 L	TWB 12LX	<b>83,25 €</b>
18 L	TWB 18LX	<b>95,90 €</b>
24 L	TWB 24LX	<b>99,55 €</b>
35 L	TWB 35LV	<b>162,75 €</b>

Vaso de expansión con membrana recambiable para circuitos de calefacción. Temperatura de trabajo: -10°C - +100°C. Color de pintura exterior: RAL 3000. Membrana en goma EPDM.



### VR, sin Patas 8 bar

REFERENCIA	CON.	VOL.	MEDIDA	PRECIO
AADRE00R01BD1	¾"	5 L	160 x 300 mm	<b>34,30 €</b>
AAERE00R01BA1	¾"	8 L	200 x 316 mm	<b>35,80 €</b>
AAFRE00R01BA1	¾"	12 L	280 x 295 mm	<b>37,44 €</b>
AAGRE00R01BA1	¾"	18 L	280 x 430 mm	<b>41,98 €</b>
AAIRE00R01DA1	¾"	24 L	280 x 483 mm	<b>51,67 €</b>
AAJRE00R01DA1	¾"	35 L	365 x 440 mm	<b>74,76 €</b>



### VRV, con Patas 8 bar

REFERENCIA	CON.	VOL.	MEDIDA	PRECIO
AAJRE01R01DA1	¾"	35 L	365 x 450 mm	<b>89,90 €</b>
AAKRE01R01DA1	¾"	50 L	365 x 582 mm	<b>116,47 €</b>
AAMRE01R01EA1	1"	80 L	415 x 717 mm	<b>169,93 €</b>
AANRE01R01EA1	1"	100 L	495 x 675 mm	<b>242,35 €</b>
AAPRE01R01EA1	1"	150 L	550 x 790 mm	<b>299,88 €</b>
AAQRE01R21EA1	1"	200 L	600 x 1085 mm	<b>383,40 €</b>
AARRE01R21EA1	1"	250 L	650 x 1 051 mm	<b>436,13 €</b>
AASRE01R21EA1	1"	300 L	650 x 1 212 mm	<b>556,03 €</b>
AATRE01R21FA1	1¼"	400 L	750 x 1 198 mm	<b>656,00 €</b>
AAURE01R21FA1	1¼"	500 L	750 x 1 438 mm	<b>1 068,91 €</b>
AAVRE01R11FP1	1¼"	600 L	750 x 1 634 mm	<b>Consultar</b>



### VRV, con Patas 10 bar

REFERENCIA	CON.	VOL.	MEDIDA	PRECIO
AAXRH31R31GP0	2"	750 L	800 x 1 850 mm	<b>Consultar</b>
AAYRH31R31GP0	2"	1000 L	800 x 2 180 mm	<b>Consultar</b>

**ACS Multifunción**

Vaso con membrana recambiable para circuitos de agua sanitaria.  
Presión: 10 Bar.  
Temperatura de trabajo: -10°C - +100°C.  
Color de pintura exterior: RAL 9010.  
Membrana en goma EPDM.



**AR+**

REFERENCIA	CON.	VOL.	MEDIDA	PRECIO
AADML00W07JD1	¾"	5 L	160 x 300 mm	<b>44,64 €</b>
AAEML00W07JA1	¾"	8 L	200 x 316 mm	<b>49,66 €</b>
AAFML00W07JA1	¾"	12 L	280 x 295 mm	<b>55,33 €</b>
AAGML00W07JC1	¾"	18 L	280 x 430 mm	<b>62,24 €</b>
AAIML00W07LA1	1"	24 L	280 x 483 mm	<b>71,81 €</b>
AAJML00W07LA1	1"	35 L	365 x 440 mm	<b>177,26 €</b>

**Solar**

Vaso de expansión con membrana recambiable para circuitos solares.  
Presión: 10 Bar.  
Temperatura de trabajo: -10°C - +140°C.  
Color de pintura exterior: RAL 9010.  
Membrana en goma EPDM HT.



**VS**

REFERENCIA	CON.	VOL.	MEDIDA	PRECIO
AAEPL00W01BA0	¾"	8 L	200 x 316 mm	<b>41,78 €</b>
AAFPL00W01BA1	¾"	12 L	280 x 295 mm	<b>47,89 €</b>
AAGPL00W01BA1	¾"	18 L	280 x 430 mm	<b>52,07 €</b>
AAIPL00W01DA1	¾"	24 L	280 x 483 mm	<b>61,62 €</b>

**AVR+, con Patas**



REFERENCIA	CON.	VOL.	MEDIDA	PRECIO
AAKML00W07LA1	1"	50 L	365 x 720 mm	<b>213,55 €</b>
AANML00W07LA1	1"	100 L	495 x 855 mm	<b>299,60 €</b>
AAPML01W17LA1	1"	150 L	550 x 975 mm	<b>Consultar</b>
AAQML01W17MA1	1¼"	200 L	600 x 1 085 mm	<b>Consultar</b>
AAAML02W17MA1	1¼"	300 L	650 x 1 240 mm	<b>Consultar</b>

**VSV, con Patas**



REFERENCIA	CON.	VOL.	MEDIDA	PRECIO
AAJPL01W01DA1	¾"	35 L	365 x 450 mm	<b>149,62 €</b>
AAKPL01W01DA1	¾"	50 L	365 x 582 mm	<b>173,96 €</b>
AAMPL01W01EA1	1"	80 L	415 x 717 mm	<b>219,32 €</b>
AANPL01W01EA1	1"	100 L	495 x 675 mm	<b>319,46 €</b>
AAPPL01W01EA1	1"	150 L	550 x 790 mm	<b>Consultar</b>
AAQPL01W01EA1	1"	200 L	600 x 1 085 mm	<b>Consultar</b>



# **Bombas Circuladoras**

# **05**

# 01. Bombas Circuladoras de Calefacción



## Evosta 2

BOMBAS ELECTRÓNICAS ROTOR HÚMEDO PARA INSTALACIONES DE CALEFACCIÓN, ACONDICIONAMIENTO Y REFRIGERACIÓN

- Electrónica con inverter que adapta automáticamente el rendimiento de la bomba a los requisitos del sistema.
- Se suministra con cubierta aislante.
- Fácil de configurar: un único botón de configuración secuencial.
- Dispone de display donde se muestra la altura en metros de la curva seleccionada, el consumo, la altura y el caudal instantáneos.



MODELO	REFERENCIA	CONEXIÓN	LONGITUD ENTRE CONEX.	PRECIO
40-70/130 1"	60231855	DN15 (G - 1")	130 mm	<b>215 €</b>
40-70/130	60231853	DN25 (G - 1½")	130 mm	<b>215 €</b>
40-70/180	60231852	DN25 (G - 1½")	180 mm	<b>215 €</b>
40-70/180 X	60231862	DN32 (G - 2")	180 mm	<b>215 €</b>

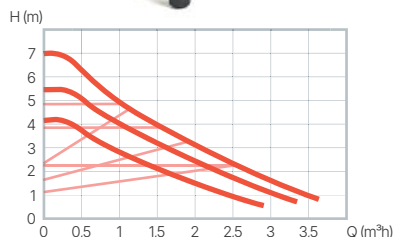

## Evosta 3

BOMBAS ELECTRÓNICAS ROTOR HÚMEDO PARA INSTALACIONES DE CALEFACCIÓN, ACONDICIONAMIENTO Y REFRIGERACIÓN

- Electrónica con inverter que adapta automáticamente el rendimiento de la bomba a los requisitos del sistema.
- Se suministra con cubierta aislante.
- Fácil de configurar: un único botón de configuración secuencial.
- Dispone de display donde se muestra la altura en metros de la curva seleccionada, el consumo, la altura y el caudal instantáneos.



MODELO	REFERENCIA	CONEXIÓN	LONGITUD ENTRE CONEX.	PRECIO
80/180	60185505	DN25 (G - 1½")	180 mm	<b>400 €</b>

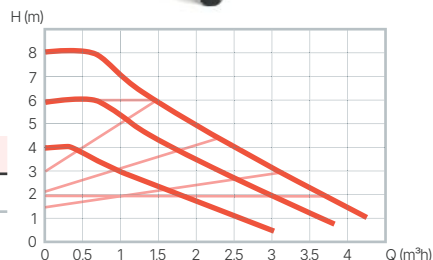

## Evoplus M&L

BOMBAS ELECTRÓNICAS ROTOR HÚMEDO PARA INSTALACIONES DE CALEFACCIÓN, ACONDICIONAMIENTO Y REFRIGERACIÓN

- Con pantalla retroiluminada en el panel de control, 4 botones de navegación y menú en cascada. Interfaz de usuario fácil e intuitiva, configuración sencilla.
- Construido con parte hidráulica de fundición y motor síncrono de rotor húmedo.

\*Mismo Display que el de la bomba Evoplus Small + 2 parámetros visualizables añadidos: E - altura de impulsión y T - Temperatura del líquido.



MODELO	REFERENCIA	CONEXIÓN	LONGITUD ENTRE CONEX.	PRECIO
120/220.32 M	60150962	DN32 PN6	220 mm	<b>1530 €</b>
80/220.40 M	60150965	DN40 PN10	220 mm	<b>1568 €</b>
100/220.40 M	60150966	DN40 PN10	220 mm	<b>1683 €</b>
120/250.40 M	60150967	DN40 PN10	250 mm	<b>1801 €</b>
80/240.50 M	60150972	DN50 PN10	240 mm	<b>2 076 €</b>
100/280.50 M	60150973	DN50 PN10	280 mm	<b>2 237 €</b>
120/280.50 M	60150974	DN50 PN10	280 mm	<b>2 410 €</b>

Q (m³/h)	0	4,2	5,4	7,2	9,6	12	14,4	18	24	30
12	11,5	10,7	9,5	7,9	6,3	4,7	2,2	-	-	-
8	-	7,9	7,4	6,1	5	3,7	2	-	-	-
10	-	-	9,7	8,3	7	5,5	3,5	-	-	-
12	-	-	11,5	10,1	8,7	7,3	5,2	-	-	-
8	-	-	7,4	6,6	5,9	5,2	4,2	2,6	-	-
10	-	-	9,4	8,4	7,5	6,7	5,5	3,6	2	-
12	-	-	11	9,9	9	8,2	6,9	4,8	3	-

## Evoplus Small

BOMBAS ELECTRÓNICAS ROTOR HÚMEDO PARA INSTALACIONES DE CALEFACCIÓN, ACONDICIONAMIENTO Y REFRIGERACIÓN

- Con pantalla retroiluminada en el panel de control, 4 botones de navegación y menú en cascada. Interfaz de usuario fácil e intuitiva, configuración sencilla.
- La versión simple se suministra con cubierta aislante para reducir las pérdidas por dispersión de calor y la formación de condensación.

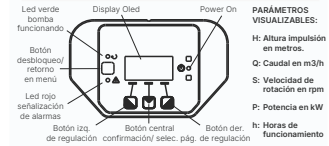

MODELO	REFERENCIA	CONEXIÓN	LONGITUD ENTRE CONEX.	PRECIO
80/180 M	660150940	1½"	180 mm	<b>864 €</b>
110/180 M	60150941	1½"	180 mm	<b>966 €</b>
110/180 XM	60150945	1½"	180 mm	<b>1 014 €</b>

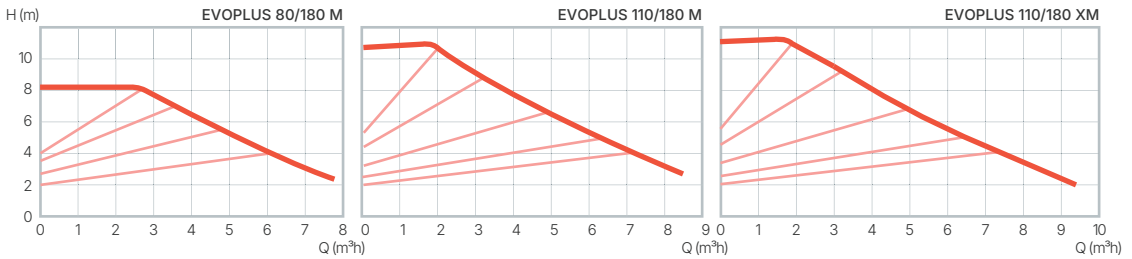

## BOMBAS CIRCULADORAS DE ACS

### VS

BOMBAS CIRCULADORAS ROTOR HÚMEDO PARA SISTEMAS DE AGUA CALIENTE SANITARIA

- Adecuada para sistemas de energía solar.
- Cuerpo bomba de bronce.



MODELO	REFERENCIA	CONEXIÓN	LONGITUD ENTRE CONEX.	PRECIO
VS 8/150 M	60182217	1½"	150 mm	<b>273 €</b>
VS 16/150 M	60182216	1½"	150 mm	<b>330 €</b>
VS 35/150 M	60182215	1½"	150 mm	<b>369 €</b>
VS 65/150 M	60182213	1½"	150 mm	<b>394 €</b>

Q (m³/h)	0	0,6	1,2	1,8	2,4	3,0	3,6
	0,83	0,75	0,52	0,22	-	-	-
	1,82	1,75	1,65	1,44	1,07	0,6	-
	4,1	3,7	3,3	2,82	2,2	1,3	-
	5,47	4,96	4,21	3,57	2,84	2,01	1,04

## Evosta 2 San

BOMBAS CIRCULADORAS ROTOR HÚMEDO AGUA CALIENTE SANITARIA

- Electrónica con inverter que adapta automáticamente el rendimiento de la bomba a los requisitos del sistema
- Cuerpo bomba de bronce.
- Ideal para sustituir los viejos circuladores de 3 velocidades.



MODELO	REFERENCIA	CONEXIÓN	LONGITUD ENTRE CONEX.	PRECIO
40-70/150	60186164	DN25 (G-1½")	150 mm	<b>387 €</b>

Q (m³/h)	0	0,9	1,8	2,4	3,0	3,6	4,2
	6,9	5,1	3,4	2,4	1,6	0,8	-

## 02. Bombas Circuladoras de Calefacción

## Alpha1 L

BOMBAS ELECTRÓNICAS ROTOR HÚMEDO PARA INSTALACIONES DE TODO TIPO DE CIRCUITOS DE CALEFACCIÓN

- Eje cerámico y cojinetes resistentes al desgaste y a prueba de partículas, fibras y magnetita durante toda su vida útil.
- Su interfaz sencilla e intuitiva hace que la sustitución y reconfiguración sean fáciles y rápidas.
- Tornillo de desbloqueo accesible desde la parte delantera.
- Cableado eléctrico mediante la "clavija de instalación", instalación en múltiples posiciones.



## ESPECIFICACIONES TÉCNICAS

Grado de protección	IPX4D
Nivel de presión sonora	43 dB(A)
Grado de temperatura	TF95
Consumo eléctrico	4-60 W
Q <sub>máx</sub>	3,8 m <sup>3</sup> /h
H <sub>máx</sub>	6,5 m
IEE	≤ 0,23
Temperatura del líquido	+ 2°C a + 95°C
Temperatura ambiente	0°C a + 55°C

MODELO	REFERENCIA	CONEXIÓN	LONGITUD ENTRE CONEX.	PRECIO
25-40	99160578	G1½"	130 mm	<b>289 €</b>
25-40	99160579	G1½"	180 mm	<b>289 €</b>
25-60	99160583	G1½"	180 mm	<b>332 €</b>
25-60	99160584	G1½"	180 mm	<b>332 €</b>
32-60	99160590	G2"	180 mm	<b>350 €</b>

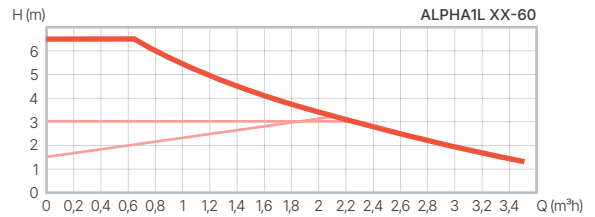
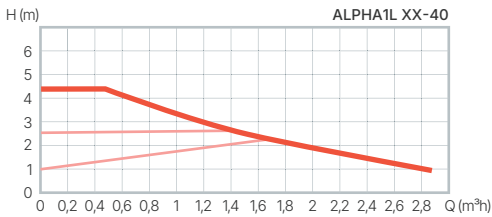

## Magna1

CIRCULADORAS ELECTRÓNICAS PARA INSTALACIONES DOMÉSTICAS DE CALEFACCIÓN, CLIMATIZACIÓN Y REFRIGERACIÓN

- Supervisión mediante relé de fallo, que aporta una gran tranquilidad.
- Entrada digital arranque/parada disponible para control remoto de la bomba.
- Alta eficiencia que garantiza un ahorro de electricidad sustancial.
- Configuración y funcionamiento sencillos mediante una interfaz simple.
- Sin necesidad de mantenimiento gracias al diseño de tipo rotor encapsulado.



MODELO	REFERENCIA	CONEXIÓN	LONGITUD ENTRE CONEX.	PRECIO
25-80	99221213	G1½"	180 mm	<b>1520 €</b>
25-100	99221214	G1½"	180 mm	<b>1684 €</b>
32-100	99221236	G2"	180 mm	<b>1806 €</b>
32-120	99221281	G2"	180 mm	<b>1999 €</b>

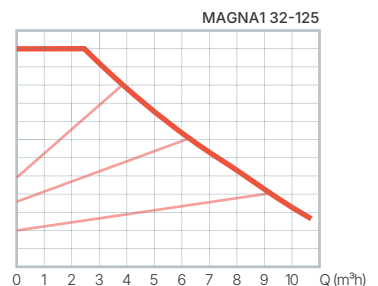
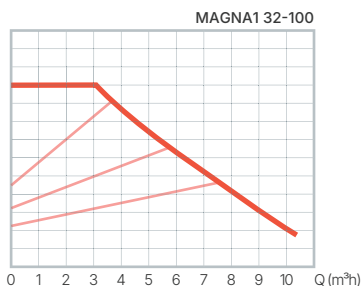
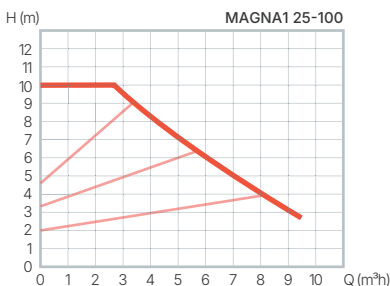
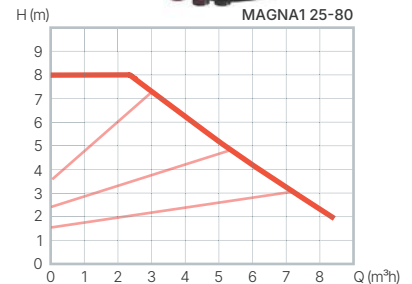

## Magna1

BOMBAS ELECTRÓNICAS ROTOR HÚMEDO PARA INSTALACIONES DE CIRCUITOS DE CALEFACCIÓN Y REFRIGERACIÓN

- Supervisión mediante relé de fallo, que aporta una gran tranquilidad.
- Entrada digital arranque/parada disponible para control remoto de la bomba.
- Alta eficiencia que garantiza un ahorro de electricidad sustancial.
- Configuración y funcionamiento sencillos mediante una interfaz simple.
- Sin necesidad de mantenimiento gracias al diseño de tipo rotor encapsulado.

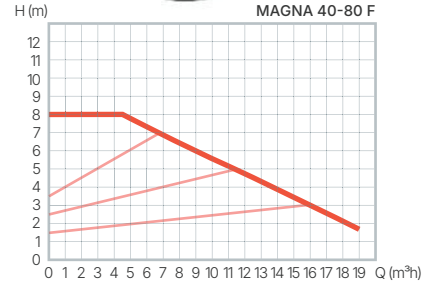

MODELO	REFERENCIA	CONEXIÓN	LONGITUD ENTRE CONEX.	PRECIO
40-80 F	99221303	DN 40	220 mm	<b>2 485 €</b>
40-120 F	99221305	DN 40	250 mm	<b>3 043 €</b>
50-60 F	99221333	DN 50	240 mm	<b>3 228 €</b>
50-80 F	99221334	DN 50	240 mm	<b>3 554 €</b>
50-120 F	99221336	DN 50	280 mm	<b>3 972 €</b>

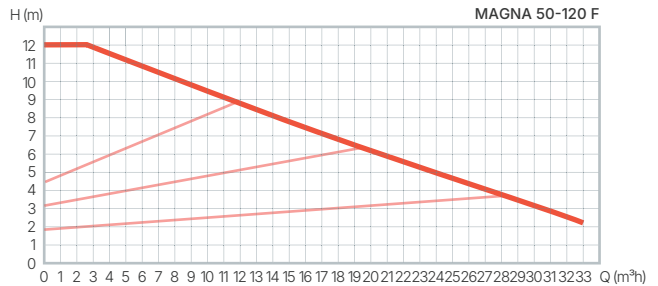
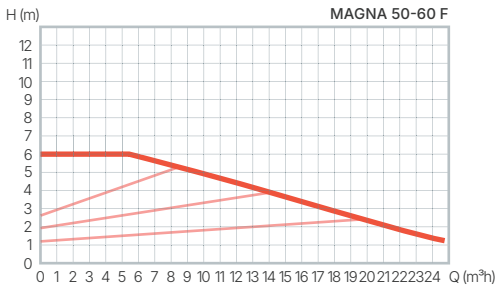
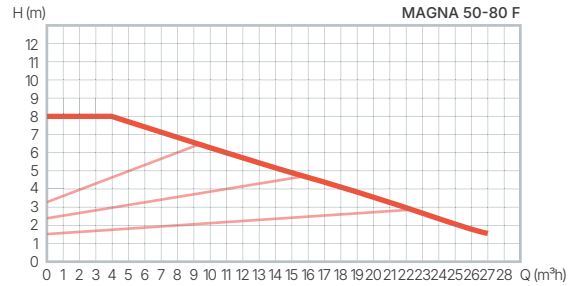
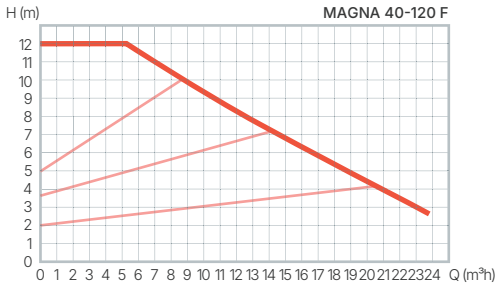

## BOMBAS CIRCULADORAS DE ACS

### Comfort PM

RECIRCULADORA DOMÉSTICA PARA AGUA CALIENTE SANITARIA

- Cuerpo de bomba en latón.
- Suministrada con kit aislamiento en polipropileno EPP.



MODELO	REFERENCIA	CONEXIÓN	LONGITUD ENTRE CONEX.	PRECIO
15/14 B PM	97916771	Rp 1/2"	80 mm	<b>274 €</b>
15-14 BX PM	97916772	G1"	140 mm	<b>310 €</b>
15/14 BA PM	97916757	Rp 1/2"	80 mm	<b>453 €</b>

#### ESPECIFICACIONES TÉCNICAS

Grado de protección	IP 44
Tensión de alimentación	1 x 230 V
Presión máxima de trabajo	10 bar
Clase aislamiento	F
Caudal	hasta 0,6 m³/h
Tª líquido	+2 °C a 95° C / +60 °C máx.



**Conductos  
Chimeneas**

**06**

## 01. Dinak DP

CHIMENEA MODULAR METÁLICA EN  
ACERO INOXIDABLE POLICOMBUSTIBLE.  
Material: Interior 316 L / Exterior 304



### Módulo Recto | 020 L 960 mm



REFERENCIA	MEDIDA	PRECIO
0301 12 020	ø125 mm	<b>167,54 €</b>
0301 15 020	ø150 mm	<b>187,16 €</b>
0301 17 020	ø175 mm	<b>209,28 €</b>
0301 20 020	ø200 mm	<b>255,98 €</b>
0301 25 020	ø250 mm	<b>327,17 €</b>
0301 30 020	ø300 mm	<b>391,49 €</b>

### Módulo Extensible | 023 L 370 - 550 mm



REFERENCIA	MEDIDA	PRECIO
0301 12 023	ø125 mm	<b>162,63€</b>
0301 15 023	ø150 mm	<b>179,83 €</b>
0301 17 023	ø175 mm	<b>201,96 €</b>
0301 20 023	ø200 mm	<b>238,78 €</b>
0301 25 023	ø250 mm	<b>290,30 €</b>
0301 30 023	ø300 mm	<b>341,89 €</b>

### Módulo Recto | 025 L 290 mm



REFERENCIA	MEDIDA	PRECIO
0301 12 025	ø125 mm	<b>86,00 €</b>
0301 15 025	ø150 mm	<b>95,82 €</b>
0301 17 025	ø175 mm	<b>110,62 €</b>
0301 20 025	ø200 mm	<b>130,66 €</b>
0301 25 025	ø250 mm	<b>160,16 €</b>
0301 30 025	ø300 mm	<b>187,16 €</b>

### Módulo Recto | 024 L 460 mm



REFERENCIA	MEDIDA	PRECIO
0301 12 024	ø125 mm	<b>103,17 €</b>
0301 15 024	ø150 mm	<b>115,46 €</b>
0301 17 024	ø175 mm	<b>130,66 €</b>
0301 20 024	ø200 mm	<b>157,68 €</b>
0301 25 024	ø250 mm	<b>189,63 €</b>
0301 30 024	ø300 mm	<b>238,78 €</b>

### Módulo Extensible | 022 L 550 - 900 mm



REFERENCIA	MEDIDA	PRECIO
0301 12 022	ø125 mm	<b>211,72 €</b>
0301 15 022	ø150 mm	<b>236,33 €</b>
0301 17 022	ø175 mm	<b>260,84 €</b>
0301 20 022	ø200 mm	<b>312,49 €</b>
0301 25 022	ø250 mm	<b>391,49 €</b>
0301 30 022	ø300 mm	<b>450,43 €</b>

**Colector de Hollín | 060**

REFERENCIA	MEDIDA	PRECIO
0319 12 060	ø125 mm	<b>26,81 €</b>
0319 15 060	ø150 mm	<b>29,04 €</b>
0319 17 060	ø175 mm	<b>33,52 €</b>
0319 20 060	ø200 mm	<b>37,95 €</b>
0319 25 060	ø250 mm	<b>44,68 €</b>
0319 30 060	ø300 mm	<b>55,84 €</b>

**Colector de Hollín | 061 con Desagüe**

REFERENCIA	MEDIDA	PRECIO
0319 12 061	ø125 mm	<b>37,95 €</b>
0319 15 061	ø150 mm	<b>40,23 €</b>
0319 17 061	ø175 mm	<b>42,43 €</b>
0319 20 061	ø200 mm	<b>49,17 €</b>
0319 25 061	ø250 mm	<b>58,10 €</b>
0319 30 061	ø300 mm	<b>67,01 €</b>

**Te 135° | 030**

REFERENCIA	MEDIDA	PRECIO
0301 12 030	ø125 mm	<b>337,01 €</b>
0301 15 030	ø150 mm	<b>366,91 €</b>
0301 17 030	ø175 mm	<b>401,28 €</b>
0301 20 030	ø200 mm	<b>457,84 €</b>
0301 25 030	ø250 mm	<b>748,17 €</b>
0301 30 030	ø300 mm	<b>848,86 €</b>

**Te 90° | 031**

REFERENCIA	MEDIDA	PRECIO
0301 12 031	ø125 mm	<b>197,00 €</b>
0301 15 031	ø150 mm	<b>219,06 €</b>
0301 17 031	ø175 mm	<b>305,03 €</b>
0301 20 031	ø200 mm	<b>341,89 €</b>
0301 25 031	ø250 mm	<b>416,07 €</b>
0301 30 031	ø300 mm	<b>484,85 €</b>

**Codo 45° | 040**

REFERENCIA	MEDIDA	PRECIO
0301 12 040	ø125 mm	<b>113,04 €</b>
0301 15 040	ø150 mm	<b>125,77 €</b>
0301 17 040	ø175 mm	<b>142,94 €</b>
0301 20 040	ø200 mm	<b>165,07 €</b>
0301 25 040	ø250 mm	<b>199,47 €</b>
0301 30 040	ø300 mm	<b>236,33 €</b>

**Codo 90° | 433**

REFERENCIA	MEDIDA	PRECIO
0301 12 433	ø125 mm	<b>234,07 €</b>
0301 15 433	ø150 mm	<b>260,35 €</b>
0301 17 433	ø175 mm	<b>295,93 €</b>
0301 20 433	ø200 mm	<b>341,75 €</b>
0301 25 433	ø250 mm	<b>412,97 €</b>
0301 30 433	ø300 mm	<b>489,27 €</b>

## Abrazadera de Unión | 070



REFERENCIA	MEDIDA	PRECIO
0309 12 070	ø125 mm	<b>13,09 €</b>
0309 15 070	ø150 mm	<b>13,80 €</b>
0309 17 070	ø175 mm	<b>14,55 €</b>
0309 20 070	ø200 mm	<b>16,77 €</b>
0309 25 070	ø250 mm	<b>20,12 €</b>
0309 30 070	ø300 mm	<b>22,37 €</b>

## Abrazadera de Vientos | 110



REFERENCIA	MEDIDA	PRECIO
0309 12 110	ø125 mm	<b>35,73 €</b>
0309 15 110	ø150 mm	<b>35,73 €</b>
0309 17 110	ø175 mm	<b>37,95 €</b>
0309 20 110	ø200 mm	<b>40,23 €</b>
0309 25 110	ø250 mm	<b>44,68 €</b>
0309 30 110	ø300 mm	<b>49,17 €</b>

## Anclaje Intermedio | 080



REFERENCIA	MEDIDA	PRECIO
0309 12 080	ø125 mm	<b>35,73 €</b>
0309 15 080	ø150 mm	<b>36,90 €</b>
0309 17 080	ø175 mm	<b>37,95 €</b>
0309 20 080	ø200 mm	<b>41,40 €</b>
0309 25 080	ø250 mm	<b>46,94 €</b>
0309 30 080	ø300 mm	<b>53,59 €</b>

## Anclaje Intermedio Plano | 086



REFERENCIA	MEDIDA	PRECIO
0309 12 086	ø125 mm	<b>35,73 €</b>
0309 15 086	ø150 mm	<b>36,90 €</b>
0309 17 086	ø175 mm	<b>37,95 €</b>
0309 20 086	ø200 mm	<b>41,40 €</b>
0309 25 086	ø250 mm	<b>46,94 €</b>
0309 30 086	ø300 mm	<b>53,59 €</b>

Anclaje Regulable | 083  
L 70-120 mm

REFERENCIA	MEDIDA	PRECIO
0309 12 083	ø125 mm	<b>39,51 €</b>
0309 15 083	ø150 mm	<b>40,58 €</b>
0309 17 083	ø175 mm	<b>41,40 €</b>
0309 20 083	ø200 mm	<b>43,58 €</b>
0309 25 083	ø250 mm	<b>49,42 €</b>
0309 30 083	ø300 mm	<b>56,50 €</b>

Anclaje Regulable Plano | 831  
L 70-120 mm

REFERENCIA	MEDIDA	PRECIO
0309 12 831	ø125 mm	<b>39,51 €</b>
0309 15 831	ø150 mm	<b>40,58 €</b>
0309 17 831	ø175 mm	<b>41,40 €</b>
0309 20 831	ø200 mm	<b>43,58 €</b>
0309 25 831	ø250 mm	<b>49,42 €</b>
0309 30 831	ø300 mm	<b>56,50 €</b>

**Sombrete | 010**

REFERENCIA	MEDIDA	PRECIO
0301 12 010	ø125 mm	<b>107,26 €</b>
0301 15 010	ø150 mm	<b>125,45 €</b>
0301 17 010	ø175 mm	<b>145,59 €</b>
0301 20 010	ø200 mm	<b>170,14 €</b>
0301 25 010	ø250 mm	<b>223,82 €</b>
0301 30 010	ø300 mm	<b>272,87 €</b>

**Salida Libre | 011**

REFERENCIA	MEDIDA	PRECIO
0301 12 011	ø125 mm	<b>81,44 €</b>
0301 15 011 DW	ø150 mm	<b>87,44 €</b>
0301 17 011	ø175 mm	<b>96,55 €</b>
0301 20 011 DW	ø200 mm	<b>123,64 €</b>
0301 25 011 DW	ø250 mm	<b>147,78 €</b>
0301 30 011 DW	ø300 mm	<b>178,38 €</b>

**Acoplamiento DP a Caldera | 100**

REFERENCIA	MEDIDA	PRECIO
ACOPLAMIENTO ø125		
0301 12 100	ø129 mm	<b>43,01 €</b>
0301 CJ 100	ø133 mm	<b>77,41 €</b>
0301 M0 100	ø154 mm	<b>120,40 €</b>
ACOPLAMIENTO ø150		
0301 B5 100	ø154 mm	<b>149,67 €</b>
0301 NP 100	ø164 mm	<b>96,21 €</b>
0301 17 100	ø179 mm	<b>53,46 €</b>
ACOPLAMIENTO ø175		
0301 DZ 100	ø154 mm	<b>96,21 €</b>
0301 M5 100	ø164 mm	<b>149,67 €</b>
0301 15 100	ø179 mm	<b>46,33 €</b>
0301 ZD 100	ø183 mm	<b>129,71 €</b>
0301 M2 100	ø204 mm	<b>129,71 €</b>
ACOPLAMIENTO ø200		
0301 C9 100	ø179 mm	<b>151,57 €</b>
0301 EA 100	ø184 mm	<b>97,44 €</b>
0301 20 100	ø204 mm	<b>54,13 €</b>

**Salida Antiviento Pro | 12B**

REFERENCIA	MEDIDA	PRECIO
0301 12 12B	ø125 mm	<b>118,77 €</b>
0301 15 12B	ø150 mm	<b>138,88 €</b>
0301 17 12B	ø175 mm	<b>161,23 €</b>
0301 20 12B	ø200 mm	<b>188,02 €</b>
0301 25 12B	ø250 mm	<b>246,07 €</b>
0301 30 12B	ø300 mm	<b>299,65 €</b>

**Estabilizador de Tiro Gama DP | 122**

REFERENCIA	MEDIDA	PRECIO
0301 12 122	ø125 mm	<b>350,06 €</b>
0301 15 122	ø150 mm	<b>355,44 €</b>
0301 18 122	ø175 mm	<b>560,73 €</b>
0301 20 122	ø200 mm	<b>564,90 €</b>
0301 25 122	ø250 mm	<b>739,35 €</b>
0301 30 122	ø300 mm	<b>757,13 €</b>

\*CONSULTAR STOCK

## 02. DW Pellets

CHIMENEA MODULAR DE DOBLE PARED AISLADA.

Material: Interior 316 L / Exterior 304



### Módulo Extensible | 022 L 530 - 880 mm



REFERENCIA	MEDIDA	PRECIO
0301 08 022 DW	ø80 mm	<b>161,96 €</b>
0301 10 022 DW	ø100 mm	<b>179,15 €</b>

### Módulo Recto | 020 L 940 mm

REFERENCIA	MEDIDA	PRECIO
0301 08 020 DW	ø80 mm	<b>132,66 €</b>
0301 10 020 DW	ø100 mm	<b>143,56 €</b>



### Módulo Extensible | 023 L 350 - 530 mm



REFERENCIA	MEDIDA	PRECIO
0301 08 023 DW	ø80 mm	<b>124,36 €</b>
0301 10 023 DW	ø100 mm	<b>137,57 €</b>

### Módulo Recto | 024 L 440 mm

REFERENCIA	MEDIDA	PRECIO
0301 08 024 DW	ø80 mm	<b>78,91 €</b>
0301 10 024 DW	ø100 mm	<b>87,26 €</b>



### Codo 45° | 040

REFERENCIA	MEDIDA	PRECIO
0301 08 040 DW	ø80 mm	<b>101,73 €</b>
0301 10 040 DW	ø100 mm	<b>108,55 €</b>



### Módulo Recto | 025 L 270 mm

REFERENCIA	MEDIDA	PRECIO
0301 08 025 DW	ø80 mm	<b>65,85 €</b>
0301 10 025 DW	ø100 mm	<b>72,80 €</b>



### Te 90° | 031

REFERENCIA	MEDIDA	PRECIO
0301 08 031 DW	ø80 mm	<b>177,28 €</b>
0301 10 031 DW	ø100 mm	<b>189,09 €</b>



### Codo 90° | 433

REFERENCIA	MEDIDA	PRECIO
0301 08 433 DW	ø80 mm	<b>210,64 €</b>
0301 10 433 DW	ø100 mm	<b>224,71 €</b>

**Abrazadera Unión | 070**

REFERENCIA	MEDIDA	PRECIO
0309 08 070 DW	ø80 mm	<b>11,77 €</b>
0309 10 070 DW	ø100 mm	<b>12,57 €</b>

**Anclaje Intermedio Plano | 086**

REFERENCIA	MEDIDA	PRECIO
0309 08 086 DW	ø80 mm	<b>30,91 €</b>
0309 10 086 DW	ø100 mm	<b>32,96 €</b>

**Anclaje Intermedio | 080**

REFERENCIA	MEDIDA	PRECIO
0309 08 080 DW	ø80 mm	<b>30,91 €</b>
0309 10 080 DW	ø100 mm	<b>32,96 €</b>

**Sombrete | 010**

REFERENCIA	MEDIDA	PRECIO
0301 08 010 DW	ø80 mm	<b>96,53 €</b>
0301 10 010 DW	ø100 mm	<b>102,95 €</b>

\*INCLUYE ABRAZADERA DE UNIÓN

**Salida Libre | 011**

REFERENCIA	MEDIDA	PRECIO
0301 08 011 DW	ø80 mm	<b>73,29 €</b>
0301 10 011 DW	ø100 mm	<b>78,16 €</b>

**Sombrete Antilluvia | 12B**

REFERENCIA	MEDIDA	PRECIO
0301 08 12B DW	ø80 mm	<b>106,91 €</b>
0301 10 12B DW	ø100 mm	<b>114,00 €</b>

\*INCLUYE ABRAZADERA DE UNIÓN

## 03. Dinak SW

CHIMENEA MODULAR  
DE SIMPLE PARED  
(INCLUYEN JUNTAS Ø80 Y Ø100).  
Material: 316 L

\*CONSULTAR STOCK MEDIDAS Ø250 Y Ø300 MM

**Módulo Recto | 020  
L 930 mm**

REFERENCIA	MEDIDA	PRECIO
039F 08 020 SWJ	ø80 mm	<b>47,67 €</b>
039F 10 020 SWJ	ø100 mm	<b>55,11 €</b>
039F 12 020 SW	ø125 mm	<b>62,49 €</b>
039F 15 020 SW	ø150 mm	<b>75,17 €</b>
039F 17 020 SW	ø175 mm	<b>87,99 €</b>
039F 20 020 SW	ø200 mm	<b>99,63 €</b>

### Módulo Recto | 024 L 430 mm



REFERENCIA	MEDIDA	PRECIO
039F 08 024 SWJ	ø80 mm	<b>29,23 €</b>
039F 10 024 SWJ	ø100 mm	<b>33,95 €</b>
039F 12 024 SW	ø125 mm	<b>36,41 €</b>
039F 15 024 SW	ø150 mm	<b>43,77 €</b>
039F 17 024 SW	ø175 mm	<b>51,28 €</b>
039F 20 024 SW	ø200 mm	<b>58,03 €</b>

### Módulo Recto | 025 L 265 mm



REFERENCIA	MEDIDA	PRECIO
039F 08 025 SWJ	ø80 mm	<b>22,24 €</b>
039F 10 025 SWJ	ø100 mm	<b>25,91 €</b>
039F 12 025 SW	ø125 mm	<b>26,44 €</b>
039F 15 025 SW	ø150 mm	<b>31,85 €</b>
039F 17 025 SW	ø175 mm	<b>37,33 €</b>
039F 20 025 SW	ø200 mm	<b>42,17 €</b>

### Módulo Extensible | 022 L 65-373 mm



REFERENCIA	MEDIDA	PRECIO
039F 08 022 SWJ	ø80 mm	<b>43,98 €</b>
039F 10 022 SWJ	ø100 mm	<b>49,60 €</b>
039F 12 022 SW	ø125 mm	<b>60,43 €</b>
039F 15 022 SW	ø150 mm	<b>68,43 €</b>
039F 17 022 SW	ø175 mm	<b>80,78 €</b>
039F 20 022 SW	ø200 mm	<b>89,43 €</b>

### Módulo Extensible | 023 L 65-206 mm



REFERENCIA	MEDIDA	PRECIO
039F 08 023 SWJ	ø80 mm	<b>37,00 €</b>
039F 10 023 SWJ	ø100 mm	<b>41,56 €</b>
039F 12 023 SW	ø125 mm	<b>50,47 €</b>
039F 15 023 SW	ø150 mm	<b>56,52 €</b>
039F 17 023 SW	ø175 mm	<b>66,79 €</b>
039F 20 023 SW	ø200 mm	<b>73,54 €</b>

### Manguito de Unión HH | 25H



REFERENCIA	MEDIDA	PRECIO
039F 08 25H SWJ	ø80 mm	<b>23,94 €</b>
039F 10 25H SWJ	ø100 mm	<b>28,21 €</b>
039F 12 25H SW	ø125 mm	<b>23,84 €</b>
039F 15 25H SW	ø150 mm	<b>28,65 €</b>
039F 17 25H SW	ø175 mm	<b>33,60 €</b>
039F 20 25H SW	ø200 mm	<b>37,94 €</b>

### Manguito de Unión MM | 25M



REFERENCIA	MEDIDA	PRECIO
039F 08 25M SW	ø80 mm	<b>16,78 €</b>
039F 10 25M SW	ø100 mm	<b>19,32 €</b>
039F 12 25M SW	ø125 mm	<b>23,84 €</b>
039F 15 25M SW	ø150 mm	<b>28,65 €</b>
039F 17 25M SW	ø175 mm	<b>33,60 €</b>
039F 20 25M SW	ø200 mm	<b>37,94 €</b>

**Colector de Hollín | 060**

REFERENCIA	MEDIDA	PRECIO
039F 08 060 SWJ	ø80 mm	<b>23,77 €</b>
039F 10 060 SWJ	ø100 mm	<b>29,32 €</b>
039F 12 060 SW	ø125 mm	<b>27,83 €</b>
039F 15 060 SW	ø150 mm	<b>31,61 €</b>
039F 17 060 SW	ø175 mm	<b>36,39 €</b>
039F 20 060 SW	ø200 mm	<b>41,19 €</b>

**Colector de Hollín | 061 con Desagüe**

REFERENCIA	MEDIDA	PRECIO
039F 08 061 SWJ	ø80 mm	<b>37,95 €</b>
039F 10 061 SWJ	ø100 mm	<b>41,49 €</b>
039F 12 061 SW	ø125 mm	<b>41,04 €</b>
039F 15 061 SW	ø150 mm	<b>44,75 €</b>
039F 17 061 SW	ø175 mm	<b>50,82 €</b>
039F 20 061 SW	ø200 mm	<b>54,82 €</b>

**Te 135° | 030**

REFERENCIA	MEDIDA	PRECIO
039F 08 030 SWJ	ø80 mm	<b>100,86 €</b>
039F 10 030 SWJ	ø100 mm	<b>115,67 €</b>
039F 12 030 SW	ø125 mm	<b>148,74 €</b>
039F 15 030 SW	ø150 mm	<b>180,74 €</b>
039F 17 030 SW	ø175 mm	<b>205,03 €</b>
039F 20 030 SW	ø200 mm	<b>250,23 €</b>

**Te 90° | 031**

REFERENCIA	MEDIDA	PRECIO
039F 08 031 SWJ	ø80 mm	<b>59,18 €</b>
039F 10 031 SWJ	ø100 mm	<b>68,00 €</b>
039F 12 031 SW	ø125 mm	<b>84,98 €</b>
039F 15 031 SW	ø150 mm	<b>103,26 €</b>
039F 17 031 SW	ø175 mm	<b>117,20 €</b>
039F 20 031 SW	ø200 mm	<b>142,98 €</b>

**Codo 45° | 040**

REFERENCIA	MEDIDA	PRECIO
039F 08 040 SWJ	ø80 mm	<b>31,30 €</b>
039F 10 040 SWJ	ø100 mm	<b>36,44 €</b>
039F 12 040 SW	ø125 mm	<b>36,65 €</b>
039F 15 040 SW	ø150 mm	<b>41,80 €</b>
039F 17 040 SW	ø175 mm	<b>50,90 €</b>
039F 20 040 SW	ø200 mm	<b>59,15 €</b>

**Codo 90° | 433**

REFERENCIA	MEDIDA	PRECIO
039F 08 433 SWJ	ø80 mm	<b>44,67 €</b>
039F 10 433 SWJ	ø100 mm	<b>50,80 €</b>
039F 12 433 SW	ø125 mm	<b>54,34 €</b>
039F 15 433 SW	ø150 mm	<b>62,50 €</b>
039F 17 433 SW	ø175 mm	<b>77,48 €</b>
039F 20 433 SW	ø200 mm	<b>87,98 €</b>

## Abrazadera Unión | 070



REFERENCIA	MEDIDA	PRECIO
0590 08 070 SW	ø80 mm	<b>7,48 €</b>
0590 10 070 SW	ø100 mm	<b>7,48 €</b>
0590 12 070 SW	ø125 mm	<b>8,90 €</b>
0590 15 070 SW	ø150 mm	<b>9,35 €</b>
0590 17 070 SW	ø175 mm	<b>10,20 €</b>
0590 20 070 SW	ø200 mm	<b>10,29 €</b>

## Anclaje Ligero con Tuerca | 075



REFERENCIA	MEDIDA	PRECIO
0590 08 075 SW	ø80 mm	<b>11,52 €</b>
0590 10 075 SW	ø100 mm	<b>11,78 €</b>
0590 12 075 SW	ø125 mm	<b>12,63 €</b>
0590 15 075 SW	ø150 mm	<b>13,44 €</b>
0590 17 075 SW	ø175 mm	<b>21,14 €</b>
0590 20 075 SW	ø200 mm	<b>23,29 €</b>

## Sombrete | 010



REFERENCIA	MEDIDA	PRECIO
039F 08 010 SW	ø80 mm	<b>73,47 €</b>
039F 10 010 SW	ø100 mm	<b>78,97 €</b>
039F 12 010 SW	ø125 mm	<b>91,04 €</b>
039F 15 010 SW	ø150 mm	<b>104,04 €</b>
039F 17 010 SW	ø175 mm	<b>119,58 €</b>
039F 20 010 SW	ø200 mm	<b>142,11 €</b>

## Anclaje Plano | 086



REFERENCIA	MEDIDA	PRECIO
0390 08 086 SW	ø80 mm	<b>15,33 €</b>
0390 10 086 SW	ø100 mm	<b>15,68 €</b>
0390 12 086 SW	ø125 mm	<b>16,85 €</b>
0390 15 086 SW	ø150 mm	<b>17,93 €</b>
0390 17 086 SW	ø175 mm	<b>28,18 €</b>
0390 20 086 SW	ø200 mm	<b>31,02 €</b>

## Junta | 001



REFERENCIA	MEDIDA	PRECIO
0505 61 001	ø80 mm	<b>3,56 €</b>
0505 62 001	ø100 mm	<b>4,44 €</b>

## Sombrete Antilluvia | 12B



REFERENCIA	MEDIDA	PRECIO
039F 08 12B SW	ø80 mm	<b>91,95 €</b>
039F 10 12B SW	ø100 mm	<b>98,77 €</b>
039F 12 12B SW	ø125 mm	<b>112,00 €</b>
039F 15 12B SW	ø150 mm	<b>131,10 €</b>
039F 17 12B SW	ø175 mm	<b>131,11 €</b>
039F 20 12B SW	ø200 mm	<b>159,75 €</b>

Deflector Horizontal | 151  
SW Pellets

REFERENCIA	MEDIDA	PRECIO
039F 08 151 SW	ø80 mm	<b>50,54 €</b>
039F 10 151 SW	ø100 mm	<b>62,20 €</b>

### Terminal Direccional | 15H SW Pellets



REFERENCIA	MEDIDA	PRECIO
039F 08 15H SW	ø80 mm	<b>25,16 €</b>
039F 10 15H SW	ø100 mm	<b>37,30 €</b>

### Placa Remate Circular | 13D SW Pellets



REFERENCIA	MEDIDA	PRECIO
0390 08 13D SW	ø80 mm	<b>35,96 €</b>
0390 10 13D SW	ø100 mm	<b>37,33 €</b>

## TRANSFORMACIONES COMUNES PARA DP Y SW

### Transformaciones de DP a SW | 16Q



REFERENCIA	MEDIDA	PRECIO
0301 12 16Q	ø125 mm	<b>118,66 €</b>
0301 15 16Q	ø150 mm	<b>122,75 €</b>
0301 17 16Q	ø175 mm	<b>127,28 €</b>
0301 20 16Q	ø200 mm	<b>148,60 €</b>

### Transformaciones de DP a SW | 15P



REFERENCIA	MEDIDA	PRECIO
039F 12 15P SW	ø125 mm	<b>55,85 €</b>
039F 15 15P SW	ø150 mm	<b>64,19 €</b>
039F 17 15P SW	ø175 mm	<b>76,78 €</b>
039F 20 15P SW	ø200 mm	<b>85,14 €</b>

## 04. Deko Leña

CONDUCTO DE SIMPLE PARED  
PARA SALIDA DE GASES DE ESTUFAS  
DE LEÑA A LA VISTA.

Material: Acero vitrificado  
interior y exterior



### Módulo Recto | 024 L 450 mm

REFERENCIA	MEDIDA	PRECIO
039A 15 024 DEN	ø150 mm	<b>41,99 €</b>
039A 18 024 DEN	ø180 mm	<b>46,08 €</b>

### Módulo Recto | 020 L 950 mm



REFERENCIA	MEDIDA	PRECIO
039A 15 020 DEN	ø150 mm	<b>50,18 €</b>
039A 18 020 DEN	ø180 mm	<b>57,16 €</b>

### Módulo Recto | 025 L 285 mm



REFERENCIA	MEDIDA	PRECIO
039A 15 025 DEN	ø150 mm	<b>38,51 €</b>
039A 18 025 DEN	ø180 mm	<b>41,88 €</b>

### Módulo Extensible | 022 L 120-450 mm



REFERENCIA	MEDIDA	PRECIO
039A 15 022 DEN	ø150 mm	<b>61,82 €</b>
039A 18 022 DEN	ø180 mm	<b>70,65 €</b>

### Manguito MM | 25M



REFERENCIA	MEDIDA	PRECIO
039A 15 25M DEN	ø150 mm	<b>34,63 €</b>
039A 18 25M DEN	ø180 mm	<b>37,70 €</b>

### Te 90° | 031 con Entroque Macho



REFERENCIA	MEDIDA	PRECIO
039A 15 31F DEN	ø150 mm	<b>70,11 €</b>
039A 18 31F DEN	ø180 mm	<b>71,98 €</b>

### Codo 45° | 040



REFERENCIA	MEDIDA	PRECIO
039A 15 040 DEN	ø150 mm	<b>42,08 €</b>
039A 18 040 DEN	ø180 mm	<b>44,93 €</b>

### Sombrete | 010



REFERENCIA	MEDIDA	PRECIO
039A 15 010 DEN	ø150 mm	<b>76,41 €</b>
039A 18 010 DEN	ø180 mm	<b>89,74 €</b>

### Codo 90° | 433



REFERENCIA	MEDIDA	PRECIO
039A 15 433 DEN	ø150 mm	<b>51,98 €</b>
039A 18 433 DEN	ø180 mm	<b>59,77 €</b>

### Colector Hollín | 060



REFERENCIA	MEDIDA	PRECIO
039A 15 060 DEN	ø150 mm	<b>65,65 €</b>
039A 18 060 DEN	ø180 mm	<b>72,43 €</b>

### Colector Hollín | 061 con Desagüe



REFERENCIA	MEDIDA	PRECIO
039A 15 061 DEN	ø150 mm	<b>73,86 €</b>
039A 18 061 DEN	ø180 mm	<b>80,65 €</b>

### Placa Remate Circular | 113



REFERENCIA	MEDIDA	PRECIO
039A 15 113 DEN	ø150 mm	<b>34,99 €</b>
039A 18 113 DEN	ø180 mm	<b>40,55 €</b>

### Anclaje Ligero con Tuerca | 075



REFERENCIA	MEDIDA	PRECIO
0390 15 075 SWNA	ø150 mm	<b>35,65 €</b>
0390 18 075 SWNA	ø180 mm	<b>37,52 €</b>

## 05. Deko Pellets Classic

CONDUCTO DE SIMPLE PARED  
CON JUNTA DE ESTANQUEIDAD  
EN EL EXTREMO HEMBRA.

Material: Acero vitrificado  
interior y exterior



### Módulo Recto | 024 L 445 mm

REFERENCIA	MEDIDA	PRECIO
039A 08 024 PEN	ø80 mm	<b>35,75 €</b>
039A 10 024 PEN	ø100 mm	<b>41,01 €</b>



### Módulo Recto | 025 L 275 mm

REFERENCIA	MEDIDA	PRECIO
039A 08 025 PEN	ø80 mm	<b>33,83 €</b>
039A 10 025 PEN	ø100 mm	<b>38,66 €</b>



### Módulo Extensible | 023 L 360-530 mm

REFERENCIA	MEDIDA	PRECIO
039A 08 023 PEN	ø80 mm	<b>64,26 €</b>
039A 10 023 PEN	ø100 mm	<b>73,44 €</b>



### Manguito HH | 25H

REFERENCIA	MEDIDA	PRECIO
039A 08 25H PEN	ø80 mm	<b>35,60 €</b>
039A 10 25H PEN	ø100 mm	<b>41,12 €</b>



### Junta | 001

REFERENCIA	MEDIDA	PRECIO
0505 61 001	ø80 mm	<b>3,56 €</b>
0505 62 001	ø100 mm	<b>4,44 €</b>

### Módulo Recto | 020 L 945 mm

REFERENCIA	MEDIDA	PRECIO
039A 08 020 PEN	ø80 mm	<b>36,56 €</b>
039A 10 020 PEN	ø100 mm	<b>42,23 €</b>



### Módulo Extensible | 022 L 530-870 mm

REFERENCIA	MEDIDA	PRECIO
039A 08 022 PEN	ø80 mm	<b>67,89 €</b>
039A 10 022 PEN	ø100 mm	<b>77,89 €</b>



### Manguito HM | 255

REFERENCIA	MEDIDA	PRECIO
039A 08 255 PEN	ø80 mm	<b>32,29 €</b>
039A 10 255 PEN	ø100 mm	<b>36,94 €</b>



### Manguito MM | 25M

REFERENCIA	MEDIDA	PRECIO
039A 08 25M PEN	ø80 mm	<b>28,96 €</b>
039A 10 25M PEN	ø100 mm	<b>32,76 €</b>



## Te 90° | 031



REFERENCIA	MEDIDA	PRECIO
039A 08 031 PEN	ø80 mm	<b>65,43 €</b>
039A 10 031 PEN	ø100 mm	<b>67,28 €</b>

## Codo 90° | 433



REFERENCIA	MEDIDA	PRECIO
039A 08 433 PEN	ø80 mm	<b>40,07 €</b>
039A 10 433 PEN	ø100 mm	<b>44,78 €</b>

## Deflector Horizontal | 151



REFERENCIA	MEDIDA	PRECIO
039A 08 151 PEN	ø80 mm	<b>43,11 €</b>
039A 10 151 PEN	ø100 mm	<b>52,95 €</b>

## Codo 45° | 040



REFERENCIA	MEDIDA	PRECIO
039A 08 040 PEN	ø80 mm	<b>33,34 €</b>
039A 10 040 PEN	ø100 mm	<b>37,14 €</b>

## Sombrete | 010



REFERENCIA	MEDIDA	PRECIO
039A 08 010 PEN	ø80 mm	<b>69,38 €</b>
039A 10 010 PEN	ø100 mm	<b>76,27 €</b>

## Anclaje Ligero con Tuerca | 075



REFERENCIA	MEDIDA	PRECIO
0390 08 075 SWNA	ø80 mm	<b>19,56 €</b>
0390 10 075 SWNA	ø100 mm	<b>21,22 €</b>

\*INCLUYE ABRAZADERA DE UNIÓN

## Sombrete Antiviento | 012



REFERENCIA	MEDIDA	PRECIO
039A 08 012 PEN	ø80 mm	<b>98,12 €</b>
039A 10 012 PEN	ø100 mm	<b>108,10 €</b>

## Anclaje Intermedio Plano | 086



REFERENCIA	MEDIDA	PRECIO
0390 08 086 SWNA	ø80 mm	<b>26,08 €</b>
0390 10 086 SWNA	ø100 mm	<b>28,27 €</b>

\*INCLUYE ABRAZADERA DE UNIÓN

## Ampliación/Reducción MH | 026



REFERENCIA	MEDIDA	PRECIO
069A AD 026 PEN	ø80 mm - ø100 mm	<b>53,42 €</b>
069A YO 026 PEN	ø100 mm - ø80 mm	<b>52,59 €</b>

## Ampliación HH | 262



REFERENCIA	MEDIDA	PRECIO
069A Y1 262 PEN	ø80 mm - ø120 mm	<b>69,42 €</b>
069A KH 262 PEN	ø100 mm - ø110 mm	<b>63,11 €</b>

## 06. Dinak PPH SW

CONDUCTO MODULAR DE SIMPLE PARED  
CON JUNTA DE ESTANQUEIDAD (EPDM).

Material: polipropileno blanco



### Módulo Recto 2 000 mm | 20B



REFERENCIA	MEDIDA	PRECIO
059P 08 20B UVB/29	ø80 mm	<b>30,11 €</b>
059P 10 20B UVB/29	ø100 mm	<b>58,57 €</b>

### Módulo Recto 3 000 mm | 20C

REFERENCIA	MEDIDA	PRECIO
059P 08 20C UVB/29	ø80 mm	<b>43,50 €</b>
059P 10 20C UVB/29	ø100 mm	<b>90,87 €</b>

### Módulo Recto 950 mm | 020



REFERENCIA	MEDIDA	PRECIO
059P 08 020 UVB/29	ø80 mm	<b>16,46 €</b>
059P 10 020 UVB/29	ø100 mm	<b>30,87 €</b>

### Módulo Recto 450 mm | 024



REFERENCIA	MEDIDA	PRECIO
059P 08 024 UVB/29	ø80 mm	<b>11,85 €</b>
059P 10 024 UVB/29	ø100 mm	<b>19,90 €</b>

### Módulo Recto 200 mm | 025



REFERENCIA	MEDIDA	PRECIO
059P 08 025 UVB/29	ø80 mm	<b>9,68 €</b>
059P 10 025 UVB/29	ø100 mm	<b>17,50 €</b>

### Te 93° | 31A



REFERENCIA	MEDIDA	PRECIO
059A 08 31A UVB/29	ø80 mm	<b>30,43 €</b>
059A 10 31A UVB/29	ø100 mm	<b>66,41 €</b>

### Codo 45° | 040



REFERENCIA	MEDIDA	PRECIO
059P 08 040 UVB/29	ø80 mm	<b>11,28 €</b>
059P 10 040 UVB/29	ø100 mm	<b>17,21 €</b>

### Codo 87° | 043



REFERENCIA	MEDIDA	PRECIO
059P 08 043 UVB/29	ø80 mm	<b>12,09 €</b>
059P 10 043 UVB/29	ø100 mm	<b>17,29 €</b>

### Colector Hollín | 061



REFERENCIA	MEDIDA	PRECIO
059P 08 061 UVB/29	ø80 mm	<b>17,38 €</b>
059P 10 061 UVB/29	ø100 mm	<b>25,75 €</b>

### Módulo Recto 3 000 mm | 20C



REFERENCIA	MEDIDA	PRECIO
059P 08 111 UVB/37	ø80 mm	<b>5,59 €</b>

### Acomplamiento Caldera Biflujo | AFE Ferroli, Biasi, Fondital



REFERENCIA	MEDIDA	PRECIO
059P 08 AFE UVB/30	ø80 mm	<b>42,26 €</b>

### Acomplamiento Caldera Biflujo | BAR Ariston, Vaillant, Viessman



REFERENCIA	MEDIDA	PRECIO
059P 08 BAR UVB/37	ø80 mm	<b>106,85 €</b>

### Deflector | 158 INOX Horizontal Corto



REFERENCIA	MEDIDA	PRECIO
039F 08 158 SW	ø80 mm	<b>15,33 €</b>
039F 10 158 SW	ø100 mm	<b>15,68 €</b>

### Terminal Direccional | 15H



REFERENCIA	MEDIDA	PRECIO
039F 08 15H SW	ø80 mm	<b>25,16 €</b>
039F 10 15H SW	ø100 mm	<b>27,30 €</b>

### Embelecador | 13D



REFERENCIA	MEDIDA	PRECIO
0390 08 13D SW	ø80 mm	<b>35,96 €</b>
0390 10 13D SW	ø100 mm	<b>37,33 €</b>

### Junta EPDM | 001



REFERENCIA	MEDIDA	PRECIO
059E 08 001 UV/29	ø80 mm	<b>1,95 €</b>
059E 10 001 UV/29	ø100 mm	<b>4,87 €</b>

## 07. Dinak PPH Concentric

CONDUCTO MODULAR CONCÉNTRICO  
CON JUNTA DE ESTANQUEIDAD (EPDM).  
Material: polipropileno blanco

 **DINAK**

06

Conductos  
Chimenea

### Módulo Recto 950 mm | 020



REFERENCIA	MEDIDA	PRECIO
052P 06 020 EVB/30	ø60/ø100 mm	<b>40,16 €</b>
052P 08 020 EVB/30	ø80/ø125 mm	<b>49,78 €</b>

### Módulo Recto 450 mm | 024



REFERENCIA	MEDIDA	PRECIO
052P 06 024 EVB/30	ø60/ø100 mm	<b>29,21 €</b>
052P 08 024 EVB/30	ø80/ø125 mm	<b>38,76 €</b>

### Módulo Recto 200 mm | 025



REFERENCIA	MEDIDA	PRECIO
052P 06 025 EVB/30	ø60/ø100 mm	<b>27,58 €</b>
052P 08 025 EVB/30	ø80/ø125 mm	<b>33,10 €</b>

### Módulo Extensible 60-250 mm | 022



REFERENCIA	MEDIDA	PRECIO
052P 06 022 EVB/30	ø60/ø100 mm	<b>32,89 €</b>
052P 08 022 EVB/30	ø80/ø125 mm	<b>57,28 €</b>

\*CONSULTAR STOCK

### Codo 45° | 040



REFERENCIA	MEDIDA	PRECIO
054P 06 040 EVB/30	ø60/ø100 mm	<b>36,88 €</b>
054P 08 040 EVB/30	ø80/ø125 mm	<b>50,11 €</b>

### Codo 87° | 043



REFERENCIA	MEDIDA	PRECIO
054P 06 043 EVB/30	ø60/ø100 mm	<b>36,41 €</b>
054P 08 043 EVB/30	ø80/ø125 mm	<b>62,55 €</b>

### Terminal Techo Negro | 010



REFERENCIA	MEDIDA	PRECIO
052P 06 010 EVN/30	ø60/ø100 mm	<b>133,72 €</b>
05BP 08 010 EVN/30	ø80/ø125 mm	<b>140,11 €</b>

### Terminal Muro Blanco | 011



REFERENCIA	MEDIDA	PRECIO
052P 06 11F EVB/30	ø60/ø100 mm	<b>76,79 €</b>

**Terminal Muro Corto | 11R**

REFERENCIA	MEDIDA	PRECIO
05BP 06 11R EVB/30	ø60/ø100 mm	<b>16,17 €</b>
05BP 08 11R EVB/30	ø80/ø125 mm	<b>20,87 €</b>

**Salida Techo Plana | 191**

REFERENCIA	MEDIDA	PRECIO
0549 08 191 EVN/30	ø80/ø125 mm	<b>69,64 €</b>

\*CONSULTAR STOCK

**Anclaje Intermedio Plano | 086**

REFERENCIA	MEDIDA	PRECIO
0592 10 086 UVB/07	ø60/ø100 mm	<b>6,17 €</b>
0592 12 086 UVB/07	ø80/ø125 mm	<b>6,27 €</b>

**Acoplamiento Caldera | AFE  
Ferrolí, Biasi, Fondital**

REFERENCIA	MEDIDA	PRECIO
052P 06 AFE EVB/30	ø60/ø100 mm	<b>78,19 €</b>

**Acoplamiento Caldera | ABA  
Baxi, Viessman, Remeha**

REFERENCIA	MEDIDA	PRECIO
052P 06 050 EVB/30	ø60/ø100 mm	<b>78,19 €</b>

**Acoplamiento Caldera | AAR  
Ariston, Vaillant, Chaffoteaux**

REFERENCIA	MEDIDA	PRECIO
052P 06 AAR EVB/30	ø60/ø100 mm	<b>78,19 €</b>

**08. Dinak ALU SW**

CONDUCTO MODULAR DE SIMPLE PARED  
CON JUNTA DE ESTANQUEIDAD (SILICONA).  
Material: aluminio lacado blanco

**Módulo Recto MM 500 mm | 24M**

REFERENCIA	MEDIDA	PRECIO
0594 08 24M UVB/01	ø80 mm	<b>15,37 €</b>
0594 10 24M UVB/01	ø100 mm	<b>17,04 €</b>
0594 11 24M UVB/01	ø110 mm	<b>18,07 €</b>
0594 1F 24M UVB/01	ø127 mm	<b>21,86 €</b>
0594 1G 24M UVB/01	ø132 mm	<b>27,63 €</b>

**Módulo Recto MM 1 000 mm | 20M**

REFERENCIA	MEDIDA	PRECIO
0594 08 20M UVB/01	ø80 mm	<b>26,31 €</b>
0594 10 20M UVB/01	ø100 mm	<b>34,21 €</b>
0594 11 20M UVB/01	ø110 mm	<b>39,05 €</b>
0594 1F 20M UVB/01	ø127 mm	<b>44,23 €</b>
0594 1G 20M UVB/01	ø132 mm	<b>46,26 €</b>

**Manguito HH | 25H**

REFERENCIA	MEDIDA	PRECIO
0594 08 25H UVB/01	ø80 mm	<b>8,32 €</b>
0594 10 25H UVB/01	ø100 mm	<b>9,88 €</b>
0594 11 25H UVB/01	ø110 mm	<b>12,17 €</b>
0594 1F 25H UVB/01	ø127 mm	<b>13,16 €</b>
0594 1G 25H UVB/01	ø132 mm	<b>13,51 €</b>

**Codo HH 45° | 40H**

REFERENCIA	MEDIDA	PRECIO
0594 08 40H UVB/01	ø80 mm	<b>15,24 €</b>
0594 10 40H UVB/01	ø100 mm	<b>17,42 €</b>
0594 11 40H UVB/01	ø110 mm	<b>18,82 €</b>
0594 1F 40H UVB/01	ø127 mm	<b>21,71 €</b>
0594 1G 40H UVB/01	ø132 mm	<b>22,38 €</b>

**Rejilla Aspiración | 111**

REFERENCIA	MEDIDA	PRECIO
059P 08 111 UVB/37	ø80 mm	<b>5,59 €</b>

**Codo HH 87° | 436**

REFERENCIA	MEDIDA	PRECIO
0594 08 436 UVB/01	ø80 mm	<b>16,53 €</b>
0594 10 436 UVB/01	ø100 mm	<b>17,42 €</b>
0594 11 436 UVB/01	ø110 mm	<b>18,82 €</b>
0594 1F 436 UVB/01	ø127 mm	<b>21,71 €</b>
0594 1G 436 UVB/01	ø132 mm	<b>22,67 €</b>

**Antirretorno | 12G  
Horizontal o Vertical**

REFERENCIA	MEDIDA	PRECIO
059C 08 12G UVB/01	ø80 mm	<b>20,35 €</b>
059C 10 12G UVB/01	ø100 mm	<b>20,49 €</b>
059C 11 12G UVB/01	ø110 mm	<b>20,49 €</b>
059C 1F 12G UVB/01	ø127 mm	<b>22,51 €</b>
059C 1G 12G UVB/01	ø132 mm	<b>22,51 €</b>

**Terminal Lamas | 01L ALU**

REFERENCIA	MEDIDA	PRECIO
0594 10 01L UVB/01	ø100 mm	<b>17,81 €</b>
0594 11 01L UVB/01	ø110 mm	<b>19,40 €</b>
0594 1F 01L UVB/01	ø127 mm	<b>21,08 €</b>
0594 1G 01L UVB/01	ø132 mm	<b>21,08 €</b>

**Junta | 001**

REFERENCIA	MEDIDA	PRECIO
059S 08 001 UVB/01	ø80 mm	<b>2,69 €</b>

**Deflector | 158  
Horizontal Hembra**

REFERENCIA	MEDIDA	PRECIO
0390 08 158 SW	ø80 mm	<b>15,33 €</b>
0390 10 158 SW	ø100 mm	<b>15,68 €</b>

### Embellecedor Circular | 113 ALU



REFERENCIA	MEDIDA	PRECIO
0594 08 113 UVB/01	ø80 mm	<b>12,90 €</b>
0594 10 113 UVB/01	ø100 mm	<b>11,09 €</b>
0594 11 113 UVB/01	ø110 mm	<b>11,52 €</b>
0594 1F 113 UVB/01	ø127 mm	<b>12,30 €</b>
0594 1G 113 UVB/01	ø132 mm	<b>12,68 €</b>

### Anclaje Intermedio Plano | 086



REFERENCIA	MEDIDA	PRECIO
0592 08 086 UVB/07	ø80 mm	<b>5,54 €</b>
0592 10 086 UVB/07	ø100 mm	<b>6,17 €</b>
0592 11 086 UVB/07	ø110 mm	<b>6,11 €</b>
0592 12 086 UVB/07	ø127 mm	<b>6,27 €</b>
0594 1G 086 UVB/01	ø132 mm	<b>6,91 €</b>

## 09. Dinak ALU Concentric

CONDUCTO MODULAR  
CONCÉNTRICO CON JUNTA  
DE ESTANQUEIDAD (SILICONA).  
Material: aluminio lacado blanco



### Módulo Recto 950 mm | 020

REFERENCIA	MEDIDA	PRECIO
0544 06 020 EVB/01	ø60-ø100 mm	<b>43,37 €</b>
0544 8A 020 EVB/01	ø80-ø110 mm	<b>55,82 €</b>
0544 08 020 EVB/01	ø80-ø125 mm	<b>61,51 €</b>

### Módulo Recto 200 mm | 025



REFERENCIA	MEDIDA	PRECIO
0544 06 025 EVB/01	ø60-ø100 mm	<b>24,44 €</b>
0544 8A 025 EVB/01	ø80-ø110 mm	<b>27,30 €</b>
0544 08 025 EVB/01	ø80-ø125 mm	<b>26,31 €</b>

### Módulo Recto 450 mm | 024



REFERENCIA	MEDIDA	PRECIO
0544 06 024 EVB/01	ø60-ø100 mm	<b>30,11 €</b>
0544 8A 024 EVB/01	ø80-ø110 mm	<b>38,19 €</b>
0544 08 024 EVB/01	ø80-ø125 mm	<b>37,19 €</b>

### Anclaje Intermedio Plano | 086



REFERENCIA	MEDIDA	PRECIO
0592 10 086 UVB/07	ø60-ø100 mm	<b>6,17 €</b>
0592 11 086 UVB/07	ø80-ø110 mm	<b>6,11 €</b>
0592 12 086 UVB/07	ø80-ø125 mm	<b>6,27 €</b>

### Manguito HH | 25H



REFERENCIA	MEDIDA	PRECIO
0544 06 25H EVB/01	ø60-ø100 mm	<b>13,72 €</b>
0544 8A 25H EVB/01	ø80-ø110 mm	<b>18,24 €</b>
0544 08 25H EVB/01	ø80-ø125 mm	<b>21,44 €</b>

**Codo 45° MH | 040**

REFERENCIA	MEDIDA	PRECIO
0544 60 040 EVB/01	ø60-ø100 mm	<b>46,46 €</b>
0544 8A 040 EVB/01	ø80-ø110 mm	<b>47,95 €</b>
0544 08 040 EVB/01	ø80-ø125 mm	<b>57,04 €</b>

**Codo 87° MH | 043**

REFERENCIA	MEDIDA	PRECIO
0544 06 043 EVB/01	ø60-ø100 mm	<b>37,62 €</b>
0544 8A 043 EVB/01	ø80-ø110 mm	<b>43,40 €</b>
0544 08 043 EVB/01	ø80-ø125 mm	<b>63,38 €</b>

**Codo 45° HH | 40H**

REFERENCIA	MEDIDA	PRECIO
0544 06 40H EVB/01	ø60-ø100 mm	<b>45,61 €</b>
0544 8A 40H EVB/01	ø80-ø110 mm	<b>46,66 €</b>
0544 08 40H EVB/01	ø80-ø125 mm	<b>57,04 €</b>

**Codo 87° HH | 436**

REFERENCIA	MEDIDA	PRECIO
0544 06 436 EVB/01	ø60-ø100 mm	<b>35,17 €</b>
0544 8A 436 EVB/01	ø80-ø110 mm	<b>39,87 €</b>
0544 08 436 EVB/01	ø80-ø125 mm	<b>59,26 €</b>

## 10. Conductos Flexibles

**Tubo Flexible Dinaflex  
INOX 316L Doble Pared  
Bobina 6 m**

REFERENCIA	MEDIDA	PRECIO
0391 08 B06 DF	ø80 mm	<b>320,68 €</b>
0391 10 B06 DF	ø100 mm	<b>400,77 €</b>
0391 12 B06 DF	ø125 mm	<b>521,18 €</b>
0391 15 B06 DF	ø150 mm	<b>601,27 €</b>

**Tubo Flexible  
Aluminio Compactado**

REFERENCIA	MEDIDA	PRECIO
02170080150	ø80 mm	<b>5,96 €</b>
02170100100	ø100 mm	<b>6,51 €</b>
02170110080	ø110 mm	<b>7,17 €</b>
02170120080	ø120 mm	<b>7,81 €</b>
02170125080	ø125 mm	<b>8,96 €</b>
02170130060	ø130 mm	<b>9,51 €</b>
02170140045	ø140 mm	<b>10,07 €</b>
02170150045	ø150 mm	<b>10,97 €</b>
02170160045	ø160 mm	<b>12,02 €</b>
02170200020	ø200 mm	<b>14,47 €</b>
02170250020	ø250 mm	<b>20,75 €</b>
02170300010	ø300 mm	<b>26,64 €</b>

# Condiciones de Venta

## **Precios**

- Precios exclusivos para clientes profesionales, IVA no incluido.
- Ofertas válidas hasta fin de existencias, cambio de tarifa o error.
- Nuestros precios pueden ser variados sin aviso previo.

## **Pedidos**

- Cualquier condición por el comprador que no se ajuste a nuestras condiciones generales de venta se considera nula, salvo que haya sido aceptada previamente por nosotros por escrito.
- Los pedidos aceptados no podrán ser anulados cuando se haya realizado la expedición del producto o cuando no se trate de material disponible en stock (pedido única y exclusivamente para el comprador).

## **Entregas**

- Los plazos de entrega que figuren en nuestras aceptaciones de pedido, serán meramente orientativos.
- El incumplimiento del plazo de entrega, no será causa en ningún caso, de reclamación alguna por parte del comprador.
- Los retrasos de entrega que no sean directamente imputables, no serán causa justificada para la anulación por parte de comprador.

## **Envíos**

- La mercancía viaja siempre por cuenta y riesgo del comprador.
- Cualquier reclamación deberá hacerse por escrito en un plazo no superior a las 48 horas siguientes a la recepción de la mercancía.

## **Condiciones de Pago**

- Las ventas se efectuarán al contado en nuestras oficinas de A Coruña, salvo que se conceda crédito al comprador, en cuyo caso se hará efectivo en el plazo estipulado expresamente.
- El impago a su vencimiento de cualquier efecto o recibo, conllevará la inmediata suspensión de suministro y servicios.
- Toda devolución de cualquier efecto o recibo, conllevará la inmediata suspensión de suministro y servicios.
- Toda devolución de cualquier efecto se le aplicará los gastos correspondientes, según nos informe el banco en cuestión, más el 1,5€ por gasto tramitación.

## **Devoluciones**

- No se admiten sin nuestra previa autorización.
- Todo material devuelto, transcurridos 30 días de la fecha de la factura, sufrirá una deducción de un 10% en concepto de demérito y gastos de recepción, prueba e inspección.

## **Propiedad de la Mercancía**

- Barreiro e Hijos Suministros S. L. (FYCAL) se reserva el derecho de la propiedad de la mercancía suministrada, hasta que el comprador no haya satisfecho totalmente el importe de la misma, en cuyo caso se considera en concepto de depósito y custodia. La mercancía podrá ser retirada por incumplimiento de pago en el plazo previamente estipulado.

## **Impuestos**

- Se aplicarán sobre el importe de la factura de acuerdo con la legislación vigente.



FONTANERÍA | CALEFACCIÓN | CLIMATIZACIÓN  
GAS | VENTILACIÓN | BAÑO | PISCINA  
BOMBAS | DEPÓSITOS | RIEGO  
FIJACIÓN | HERRAMIENTAS

**A CORUÑA (CENTRAL)**

T. 981 174 053  
administracion@fycal.com

P.I. de Pocomaco  
5ª Avenida, nº47  
15190 - A Coruña

**DELEGACIÓN VIGO**

T. 886 129 073  
vigo@fycal.com

Camiño A Raposeira-  
Sárdoma 42, Nave E  
36214 - Vigo

**DELEGACIÓN CARBALLO**

T. 981 732 813  
carballo@fycal.com

P.I. de Bertoa  
Volframio J-5  
15100 - Carballo

**DELEGACIÓN LUGO**

T. 982 873 812  
lugo@fycal.com

P.I. As Gándaras  
E2 A2  
27003 - Lugo

**DELEGACIÓN OURENSE**

T. 988 316 251  
ourense@fycal.com

P.I. de Barreiros  
Crta. N-525, km. 230  
32915 - Ourense